

# TOSHIBA

Leading Innovation >>>



EB99819101

**R32 or R410A**

For commercial use

## *AIR CONDITIONER (SPLIT TYPE)* Installation Manual

### Indoor Unit

Model name:

Compact 4-Way Cassette type

**RAV-RM301MUT-E**

**RAV-RM401MUT-E**

**RAV-RM561MUT-E**

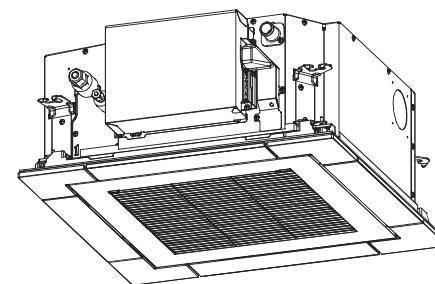

**Original instruction**

Please read this Installation Manual carefully before installing the Air Conditioner.

- This Manual describes the installation method of the indoor unit.
- For installation of the outdoor unit, follow the Installation Manual attached to the outdoor unit.

**ADOPTION OF R32 or R410A REFRIGERANT**

This Air Conditioner has adopted a refrigerant HFC (R32 or R410A) which does not destroy the ozone layer. Be sure to check the refrigerant type for outdoor unit to be combined, and then install it.

**Product information of ecodesign requirements. (Regulation (EU) 2016/2281)**  
<http://ecodesign.toshiba-airconditioning.eu/en>

**Contents**

<b>1</b>	<b>Precautions for safety</b>	<b>3</b>
<b>1</b>	<b>Précautions relatives à la sécurité</b>	<b>8</b>
<b>1</b>	<b>Vorsichtsmaßnahmen für die Sicherheit</b>	<b>13</b>
<b>1</b>	<b>Precauzioni per la sicurezza</b>	<b>18</b>
<b>1</b>	<b>Precauciones de seguridad</b>	<b>23</b>
<b>1</b>	<b>Precauções de segurança</b>	<b>28</b>
<b>1</b>	<b>Voorzorgen voor de veiligheid</b>	<b>33</b>
<b>1</b>	<b>Προφυλάξεις για ασφάλεια</b>	<b>38</b>
<b>1</b>	<b>Меры предосторожности</b>	<b>43</b>
<b>2</b>	<b>Accessory parts</b>	<b>47</b>
<b>3</b>	<b>Selection of installation place</b>	<b>47</b>
<b>4</b>	<b>Installation</b>	<b>49</b>
<b>5</b>	<b>Drain piping</b>	<b>51</b>
<b>6</b>	<b>Refrigerant piping</b>	<b>53</b>
<b>7</b>	<b>Electrical connection</b>	<b>54</b>
<b>8</b>	<b>Applicable controls</b>	<b>57</b>
<b>9</b>	<b>Test run</b>	<b>63</b>
<b>10</b>	<b>Maintenance</b>	<b>64</b>
<b>11</b>	<b>Troubleshooting</b>	<b>65</b>

Thank you for purchasing this Toshiba air conditioner.

Please read carefully through these instructions that contain important information which complies with the "Machinery" Directive (Directive 2006/42/EC), and ensure that you understand them.

After completing the installation work, hand over this Installation Manual as well as the Owner's Manual provided with the outdoor unit to the user, and ask the user to keep them in a safe place for future reference.

#### Generic denomination: Air conditioner

#### Definition of qualified installer or qualified service person

The air conditioner must be installed, maintained, repaired and removed by a qualified installer or qualified service person. When any of these jobs is to be done, ask a qualified installer or qualified service person to do them for you. A qualified installer or qualified service person is an agent who has the qualifications and knowledge described in the table below.

Agent	Qualifications and knowledge which the agent must have
Qualified installer	<ul style="list-style-type: none"> <li>The qualified installer is a person who installs, maintains, relocates and removes the air conditioners made by Toshiba Carrier Corporation. He or she has been trained to install, maintain, relocate and remove the air conditioners made by Toshiba Carrier Corporation or, alternatively, he or she has been instructed in such operations by an individual or individuals who have been trained and is thus thoroughly acquainted with the knowledge related to these operations.</li> <li>The qualified installer who is allowed to do the electrical work involved in installation, relocation and removal has the qualifications pertaining to this electrical work as stipulated by the local laws and regulations, and he or she is a person who has been trained in matters relating to electrical work on the air conditioners made by Toshiba Carrier Corporation or, alternatively, he or she has been instructed in such matters by an individual or individuals who have been trained and is thus thoroughly acquainted with the knowledge related to this work.</li> <li>The qualified installer who is allowed to do the refrigerant handling and piping work involved in installation, relocation and removal has the qualifications pertaining to this refrigerant handling and piping work as stipulated by the local laws and regulations, and he or she is a person who has been trained in matters relating to refrigerant handling and piping work on the air conditioners made by Toshiba Carrier Corporation or, alternatively, he or she has been instructed in such matters by an individual or individuals who have been trained and is thus thoroughly acquainted with the knowledge related to this work.</li> <li>The qualified installer who is allowed to work at heights has been trained in matters relating to working at heights with the air conditioners made by Toshiba Carrier Corporation or, alternatively, he or she has been instructed in such matters by an individual or individuals who have been trained and is thus thoroughly acquainted with the knowledge related to this work.</li> </ul>
Qualified service person	<ul style="list-style-type: none"> <li>The qualified service person is a person who installs, repairs, maintains, relocates and removes the air conditioners made by Toshiba Carrier Corporation. He or she has been trained to install, repair, maintain, relocate and remove the air conditioners made by Toshiba Carrier Corporation or, alternatively, he or she has been instructed in such operations by an individual or individuals who have been trained and is thus thoroughly acquainted with the knowledge related to these operations.</li> <li>The qualified service person who is allowed to do the electrical work involved in installation, repair, relocation and removal has the qualifications pertaining to this electrical work as stipulated by the local laws and regulations, and he or she is a person who has been trained in matters relating to electrical work on the air conditioners made by Toshiba Carrier Corporation or, alternatively, he or she has been instructed in such matters by an individual or individuals who have been trained and is thus thoroughly acquainted with the knowledge related to this work.</li> <li>The qualified service person who is allowed to do the refrigerant handling and piping work involved in installation, repair, relocation and removal has the qualifications pertaining to this refrigerant handling and piping work as stipulated by the local laws and regulations, and he or she is a person who has been trained in matters relating to refrigerant handling and piping work on the air conditioners made by Toshiba Carrier Corporation or, alternatively, he or she has been instructed in such matters by an individual or individuals who have been trained and is thus thoroughly acquainted with the knowledge related to this work.</li> <li>The qualified service person who is allowed to work at heights has been trained in matters relating to working at heights with the air conditioners made by Toshiba Carrier Corporation or, alternatively, he or she has been instructed in such matters by an individual or individuals who have been trained and is thus thoroughly acquainted with the knowledge related to this work.</li> </ul>

#### Definition of protective gear



When the air conditioner is to be transported, installed, maintained, repaired or removed, wear protective gloves and 'safety' work clothing.

In addition to such normal protective gear, wear the protective gear described below when undertaking the special work detailed in the table below.

Failure to wear the proper protective gear is dangerous because you will be more susceptible to injury, burns, electric shocks and other injuries.





Work undertaken	Protective gear worn
All types of work	Protective gloves 'Safety' working clothing
Electrical-related work	Gloves to provide protection for electricians Insulating shoes Clothing to provide protection from electric shock
Work done at heights (50 cm or more)	Helmets for use in industry
Transportation of heavy objects	Shoes with additional protective toe cap
Repair of outdoor unit	Gloves to provide protection for electricians

These safety cautions describe important matters concerning safety to prevent injury to users or other people and damages to property. Please read through this manual after understanding the contents below (meanings of indications), and be sure to follow the description.





Indication	Meaning of Indication
 <b>WARNING</b>	Text set off in this manner indicates that failure to adhere to the directions in the warning could result in serious bodily harm (*1) or loss of life if the product is handled improperly.
 <b>CAUTION</b>	Text set off in this manner indicates that failure to adhere to the directions in the caution could result in slight injury (*2) or damage (*3) to property if the product is handled improperly.

\*1: Serious bodily harm indicates loss of eyesight, injury, burns, electric shock, bone fracture, poisoning, and other injuries which leave aftereffect and require hospitalization or long-term treatment as an outpatient.  
\*2: Slight injury indicates injury, burns, electric shock, and other injuries which do not require hospitalization or long-term treatment as an outpatient.  
\*3: Damage to property indicates damage extending to buildings, household effects, domestic livestock, and pets.

#### MEANINGS OF SYMBOLS DISPLAYED ON THE UNIT

	<b>WARNING</b> (Risk of fire)	This mark is for R32 refrigerant only. Refrigerant type is written on nameplate of outdoor unit. In case that refrigerant type is R32, this unit uses a flammable refrigerant. If refrigerant leaks and comes in contact with fire or heating part, it will create harmful gas and there is risk of fire.
		Read the OWNER'S MANUAL carefully before operation.
		Service personnel are required to carefully read the OWNER'S MANUAL and INSTALLATION MANUAL before operation.
		Further information is available in the OWNER'S MANUAL, INSTALLATION MANUAL, and the like.

■ **Warning indications on the air conditioner unit**

Warning indication		Description
 <p><b>WARNING</b> <b>ELECTRICAL SHOCK HAZARD</b> Disconnect all remote electric power supplies before servicing.</p>	<p><b>WARNING</b> <b>ELECTRICAL SHOCK HAZARD</b> Disconnect all remote electric power supplies before servicing.</p>	
 <p><b>WARNING</b> Moving parts. Do not operate unit with grille removed. Stop the unit before the servicing.</p>	<p><b>WARNING</b> Moving parts. Do not operate unit with grille removed. Stop the unit before the servicing.</p>	
 <p><b>CAUTION</b> High temperature parts. You might get burned when removing this panel.</p>	<p><b>CAUTION</b> High temperature parts. You might get burned when removing this panel.</p>	
 <p><b>CAUTION</b> Do not touch the aluminium fins of the unit. Doing so may result in injury.</p>	<p><b>CAUTION</b> Do not touch the aluminium fins of the unit. Doing so may result in injury.</p>	
 <p><b>CAUTION</b> <b>BURST HAZARD</b> Open the service valves before the operation, otherwise there might be the burst.</p>	<p><b>CAUTION</b> <b>BURST HAZARD</b> Open the service valves before the operation, otherwise there might be the burst.</p>	

# 1 Precautions for safety

The manufacturer shall not assume any liability for the damage caused by not observing the description of this manual.

## **WARNING**

### General

- Before starting to install the air conditioner, read through the Installation Manual carefully, and follow its instructions to install the air conditioner.
- Only a qualified installer or service person is allowed to do installation work. Inappropriate installation may result in water leakage, electric shock or fire.
- Do not use any refrigerant different from the one specified for complement or replacement. Otherwise, abnormally high pressure may be generated in the refrigeration cycle, which may result in a failure or explosion of the product or an injury to your body.
- Before opening the intake grille of the indoor unit or service panel of the outdoor unit, set the circuit breaker to the OFF position. Failure to set the circuit breaker to the OFF position may result in electric shocks through contact with the interior parts. Only a qualified installer (\*1) or qualified service person (\*1) is allowed to remove the intake grille of the indoor unit or service panel of the outdoor unit and do the work required.
- Before carrying out the installation, maintenance, repair or removal work, set the circuit breaker to the OFF position. Otherwise, electric shocks may result.
- Place a “Work in progress” sign near the circuit breaker while the installation, maintenance, repair or removal work is being carried out. There is a danger of electric shocks if the circuit breaker is set to ON by mistake.
- Only a qualified installer (\*1) or qualified service person (\*1) is allowed to undertake work at heights using a stand of 50 cm or more or to remove the intake grille of the indoor unit to undertake work.
- Wear protective gloves and safety work clothing during installation, servicing and removal.
- Do not touch the aluminium fin of the unit. You may injure yourself if you do so. If the fin must be touched for some reason, first put on protective gloves and safety work clothing, and then proceed.
- Do not climb onto or place objects on top of the outdoor unit. You may fall or the objects may fall off of the outdoor unit and result in injury.

- When work is performed at heights, use a ladder which complies with the ISO 14122 standard, and follow the procedure in the ladder's instructions. Also wear a helmet for use in industry as protective gear to undertake the work.
- Before cleaning the filter or other parts of the outdoor unit, set the circuit breaker to OFF without fail, and place a "Work in progress" sign near the circuit breaker before proceeding with the work.
- Before working at heights, put a sign in place so that no-one will approach the work location, before proceeding with the work. Parts and other objects may fall from above, possibly injuring a person below. While carrying out the work, wear a helmet for protection from falling objects.
- Do not use the refrigerant other than R32 or R410A. For the refrigerant type, check the outdoor unit to be combined.
- The air conditioner must be transported in stable condition. If any part of the product is broken, contact the dealer.
- When the air conditioner must be transported by hand, carry it by two or more people.
- Do not move or repair any unit by yourself. There is high voltage inside the unit. You may get electric shock when removing the cover and main unit.
- This appliance is intended to be used by expert or trained users in shops, in light industry, or for commercial use by lay persons.

#### **Selection of installation location**

- When the air conditioner is installed in a small room, provide appropriate measures to ensure that the concentration of refrigerant leakage occur in the room does not exceed the critical level.
- Do not install in a location where flammable gas leaks are possible. If the gas leak and accumulate around the unit, it may ignite and cause a fire.
- To transport the air conditioner, wear shoes with additional protective toe caps.
- To transport the air conditioner, do not take hold of the bands around the packing carton. You may injure yourself if the bands should break.
- Install the indoor unit at least 2.5 m above the floor level since otherwise the users may injure themselves or receive electric shocks if they poke their fingers or other objects into the indoor unit while the air conditioner is running.
- Do not place any combustion appliance in a place where it is directly exposed to the wind of air conditioner, otherwise it may cause imperfect combustion.

- Appliance and pipe-work shall be installed, operated and stored in a room with a floor area larger than  $A_{\min} \text{ m}^2$ .  
How to get  $A_{\min} \text{ m}^2$ :  $A_{\min} = (M / (2.5 \times 0.22759 \times h_0))^2$   
M is the refrigerant charge amount in appliance in **kg**;  
 $h_0$  is the installation height of the appliance in **m**:  
0.6 m for floor standing / 1.8 m for wall mounted / 1.0 m for window mounted / 2.2 m for ceiling mounted.  
(R32 refrigerant models only. For detail, refer to Installation Manual of the outdoor unit.)

#### **Installation**

- When the indoor unit is to be suspended, the designated hanging bolts (M10 or W3/8) and nuts (M10 or W3/8) must be used.
- Install the air conditioner securely in a location where the base can sustain the weight adequately. If the strength is not enough, the unit may fall down resulting in injury.
- Follow the instructions in the Installation Manual to install the air conditioner. Failure to follow these instructions may cause the product to fall down or topple over or give rise to noise, vibration, water leakage or other trouble.
- Carry out the specified installation work to guard against the possibility of high winds and earthquake. If the air conditioner is not installed appropriately, a unit may topple over or fall down, causing an accident.
- If refrigerant gas has leaked during the installation work, ventilate the room immediately. If the leaked refrigerant gas comes in contact with fire, noxious gas may generate.
- Use forklift to carry in the air conditioner units and use winch or hoist at installation of them.

#### **Refrigerant piping**

- Install the refrigerant pipe securely during the installation work before operating the air conditioner. If the compressor is operated with the valve open and without refrigerant pipe, the compressor sucks air and the refrigeration cycles is over pressurized, which may cause an injury.
- Tighten the flare nut with a torque wrench in the specified manner. Excessive tighten of the flare nut may cause a crack in the flare nut after a long period, which may result in refrigerant leakage.
- After the installation work, confirm that refrigerant gas does not leak. If refrigerant gas leaks into the room and flows near a fire source, such as a cooking range, noxious gas may be generated.

- When the air conditioner has been installed or relocated, follow the instructions in the Installation Manual and purge the air completely so that no gases other than the refrigerant will be mixed in the refrigerating cycle. Failure to purge the air completely may cause the air conditioner to malfunction.
- Nitrogen gas must be used for the airtight test.
- The charge hose must be connected in such a way that it is not slack.

### **Electrical wiring**

- Only a qualified installer (\*1) or qualified service person (\*1) is allowed to carry out the electrical work of the air conditioner. Under no circumstances must this work be done by an unqualified individual since failure to carry out the work properly may result in electric shocks and/or electrical leaks.
- To connect the electrical wires, repair the electrical parts or undertake other electrical jobs, wear gloves to provide protection for electricians insulating shoes and clothing to provide protection from electric shocks. Failure to wear this protective gear may result in electric shocks.
- Use wiring that meets the specifications in the Installation Manual and the stipulations in the local regulations and laws. Use of wiring which does not meet the specifications may give rise to electric shocks, electrical leakage, smoking and/or a fire.
- Connect earth wire. (Grounding work)  
Incomplete earthing causes an electric shock.
- Do not connect earth wires to gas pipes, water pipes, and lightning conductor or telephone earth wires.
- After completing the repair or relocation work, check that the earth wires are connected properly.
- Install a circuit breaker that meets the specifications in the installation manual and the stipulations in the local regulations and laws.
- Install the circuit breaker where it can be easily accessed by the agent.
- When installing the circuit breaker outdoors, install one which is designed to be used outdoors.
- Under no circumstances, the power supply wire or the indoor and outdoor connecting wire must not be connected in the middle (Connection using a solderless terminal etc.)  
Connection trouble in the places where the wire is connected in the middle may give rise to smoking and/or a fire.

- Electrical wiring work shall be conducted according to law and regulation in the community and installation manual.  
Failure to do so may result in electrocution or short circuit.

### **Test run**

- Before operating the air conditioner after having completed the work, check that the electrical control box cover of the indoor unit and service panel of the outdoor unit are closed, and set the circuit breaker to the ON position. You may receive an electric shock if the power is turned on without first conducting these checks.
- If there is any kind of trouble (such as check code display has appeared, smell of burning, abnormal sounds, the air conditioner fails to cool or heat or water is leaking) has occurred in the air conditioner, do not touch the air conditioner yourself but set the circuit breaker to the OFF position, and contact a qualified service person. Take steps to ensure that the power will not be turned on (by marking "out of service" near the circuit breaker, for instance) until qualified service person arrives. Continuing to use the air conditioner in the trouble status may cause mechanical problems to escalate or result in electric shocks or other trouble.
- After the work has finished, use an insulation tester set (500 V Megger) to check the resistance is 1 MΩ or more between the charge section and the non-charge metal section (Earth section). If the resistance value is low, a disaster such as a leak or electric shock is caused at user's side.
- Upon completion of the installation work, check for refrigerant leaks and check the insulation resistance and water drainage. Then conduct a test run to check that the air conditioner is operating properly.

### **Explanations given to user**

- Upon completion of the installation work, tell the user where the circuit breaker is located. If the user does not know where the circuit breaker is, he or she will not be able to turn it off in the event that trouble has occurred in the air conditioner.
- After the installation work, follow the Owner's Manual to explain to the customer how to use and maintain the unit.

---

## Relocation

- Only a qualified installer (\*1) or qualified service person (\*1) is allowed to relocate the air conditioner. It is dangerous for the air conditioner to be relocated by an unqualified individual since a fire, electric shocks, injury, water leakage, noise and/or vibration may result.
  - When carrying out the pump-down work shut down the compressor before disconnecting the refrigerant pipe. Disconnecting the refrigerant pipe with the service valve left open and the compressor still operating will cause air or other gas to be sucked in, raising the pressure inside the refrigeration cycle to an abnormally high level, and possibly resulting in rupture, injury or other trouble.
- 

---

## CAUTION

**This Air Conditioner has adopted a refrigerant HFC (R32 or R410A) which does not destroy the ozone layer.**

- As the R32 or R410A refrigerant is easily affected by impurities such as moisture, oxidized film, oil, etc., due to the high pressure, be careful not to allow the moisture, dirt, existing refrigerant, refrigerating machine oil, etc., to get mixed up in the refrigeration cycle during the installation work.
  - A special tool for the R32 or R410A refrigerant is required for installation.
  - Use a new and clean piping materials for the connecting pipe so that moisture and dirt are not mixed together during the installation work.
  - When using existing pipes, follow the installation manual enclosed with the outdoor unit.
- 

(\*1) Refer to the "Definition of qualified installer or qualified service person".

Merci d'avoir acheté ce climatiseur de Toshiba.

Veillez lire attentivement ces instructions qui contiennent des informations importantes qui sont conformes à la directive « Machines » (Directive 2006/42/EC), et assurez-vous de bien les comprendre.

Après avoir terminé l'installation, remettez le manuel d'installation ainsi que le manuel d'utilisation fourni avec l'unité extérieure à l'utilisateur, et demandez-lui de le conserver dans un endroit sûr pour pouvoir le consulter en cas de besoin.

**Dénomination générique : Climatiseur**

**Définition d'un installateur qualifié ou d'un technicien d'entretien qualifié**

Le climatiseur doit être installé, entretenu, réparé et enlevé par un installateur qualifié ou un technicien d'entretien qualifié. Lorsqu'une de ces opérations doit être effectuée, demandez à un installateur qualifié ou un technicien d'entretien qualifié de les exécuter pour vous.

Un installateur qualifié ou un technicien d'entretien qualifié est un agent qui a les qualifications et les connaissances décrites dans le tableau ci-dessous.

Agent	Qualifications et connaissances que l'agent doit posséder
Installateur qualifié	<ul style="list-style-type: none"> <li>L'installateur qualifié est une personne qui installe, entretient, déplace et enlève les climatiseurs fabriqués par Toshiba Carrier Corporation. Il a été formé pour installer, entretenir, déplacer et enlever les climatiseurs fabriqués par Toshiba Carrier Corporation ou, alternativement, il a reçu des consignes concernant de telles opérations d'une ou de plusieurs personnes qui ont été formées. Par conséquent, il maîtrise très bien les connaissances relatives à ces opérations.</li> <li>L'installateur qualifié qui est autorisé à effectuer un travail électrique compris dans l'installation, le déplacement et l'enlèvement possède les qualifications nécessaires à ce travail électrique conformément aux réglementations et à la législation locales. De plus, il a été formé pour résoudre les problèmes relatifs au travail électrique sur les climatiseurs fabriqués par Toshiba Carrier Corporation ou, alternativement, il a reçu des consignes dans de tels domaines d'une ou de plusieurs personnes qui ont été formées. Par conséquent, il maîtrise très bien les connaissances relatives à ce travail.</li> <li>L'installateur qualifié qui est autorisé à manipuler du réfrigérant et à réaliser un travail de raccordement compris dans l'installation, le déplacement et l'enlèvement possède les qualifications nécessaires à cette manipulation de réfrigérant et ce travail de raccordement conformément aux réglementations et à la législation locales. De plus, il a été formé pour s'occuper des problèmes relatifs à la manipulation de réfrigérant et de travail de raccordement sur les climatiseurs fabriqués par Toshiba Carrier Corporation ou, alternativement, il a reçu des consignes dans de tels domaines d'une ou de plusieurs personnes qui ont été formées. Par conséquent, il maîtrise très bien les connaissances relatives à ce travail.</li> <li>L'installateur qualifié qui est autorisé à travailler en hauteur a été formé aux domaines relatifs au travail en hauteur avec les climatiseurs fabriqués par Toshiba Carrier Corporation ou, alternativement, il a reçu des consignes dans de tels domaines d'une ou de plusieurs personnes qui ont été formées. Par conséquent, il maîtrise très bien les connaissances relatives à ce travail.</li> </ul>
Technicien d'entretien qualifié	<ul style="list-style-type: none"> <li>Le technicien d'entretien qualifié est une personne qui installe, répare, entretient, déplace et enlève les climatiseurs fabriqués par Toshiba Carrier Corporation. Il a été formé pour installer, réparer, entretenir, déplacer et enlever les climatiseurs fabriqués par Toshiba Carrier Corporation ou, alternativement, il a reçu des consignes concernant de telles opérations d'une ou de plusieurs personnes qui ont été formées. Par conséquent, il maîtrise très bien les connaissances relatives à ces opérations.</li> <li>Le technicien d'entretien qualifié qui est autorisé à effectuer un travail électrique compris dans l'installation, la réparation, le déplacement et l'enlèvement possède les qualifications nécessaires à ce travail électrique conformément aux réglementations et à la législation locales. De plus, il a été formé pour résoudre les problèmes relatifs au travail électrique sur les climatiseurs fabriqués par Toshiba Carrier Corporation ou, alternativement, il a reçu des consignes dans de tels domaines d'une ou de plusieurs personnes qui ont été formées. Par conséquent, il maîtrise très bien les connaissances relatives à ce travail.</li> <li>Le technicien d'entretien qualifié qui est autorisé à manipuler du réfrigérant et à réaliser un travail de raccordement compris dans l'installation, la réparation, le déplacement et l'enlèvement possède les qualifications nécessaires à cette manipulation de réfrigérant et ce travail de raccordement conformément aux réglementations et à la législation locales. De plus, il a été formé pour s'occuper des problèmes relatifs à la manipulation de réfrigérant et de travail de raccordement sur les climatiseurs fabriqués par Toshiba Carrier Corporation ou, alternativement, il a reçu des consignes dans de tels domaines d'une ou de plusieurs personnes qui ont été formées. Par conséquent, il maîtrise très bien les connaissances relatives à ce travail.</li> <li>Le technicien d'entretien qualifié qui est autorisé à travailler en hauteur a été formé aux domaines relatifs au travail en hauteur avec les climatiseurs fabriqués par Toshiba Carrier Corporation ou, alternativement, il a reçu des consignes dans de tels domaines d'une ou de plusieurs personnes qui ont été formées. Par conséquent, il maîtrise très bien les connaissances relatives à ce travail.</li> </ul>

**Définition de l'équipement de protection**



Lorsque le climatiseur doit être transporté, installé, entretenu, réparé ou enlevé, portez des gants de protection et des vêtements de travail de « sécurité ».

En plus de cette tenue de protection normale, portez la tenue de protection décrite ci-dessous lorsque vous entreprenez les travaux spéciaux détaillés dans le tableau ci-dessous.

Ne pas porter la tenue de protection adéquate est dangereux car vous serez plus susceptible d'être blessé, brûlé, de subir un choc électrique ou d'autres blessures.





Travaux entrepris	Équipement de protection porté
Tous les types de travaux	Gants de protection Vêtement de travail de « sécurité »
Travaux électriques	Gants de protection pour électricien Chaussures isolantes Vêtement protégeant des décharges électriques
Travail effectué en hauteur (50 cm ou plus)	Casques utilisés dans l'industrie
Transport d'objets lourds	Chaussures avec des bouts renforcés de protection
Réparation d'unité extérieure	Gants de protection pour électricien

Ces précautions de sécurité mentionnent divers points importants pour prévenir les accidents corporels et les dommages aux équipements. Veuillez lire ce manuel après avoir pris connaissance des informations ci-dessous (significations des indications) et assurez-vous de suivre leurs descriptions.

Indication	Signification des indications
 <b>AVERTISSEMENT</b>	Le texte marqué de cette manière indique que le non-respect des directives de l'avertissement pourrait entraîner de graves blessures corporelles (*1) ou la mort si le produit n'est pas manipulé correctement.
 <b>PRÉCAUTION</b>	Le texte marqué de cette manière indique que le non-respect des directives de la précaution pourrait entraîner de graves blessures corporelles (*2) ou des dommages sur le produit (*3) si celui-ci n'est pas manipulé correctement.





\*1 : On entend par grave blessure corporelle une perte de la vue, des blessures, des brûlures, un choc électrique, une fracture, un empoisonnement et d'autres blessures qui laissent des séquelles et requièrent une hospitalisation ou un traitement de longue durée en tant que patient externe.  
 \*2 : On entend par blessure corporelle, toute blessure, brûlure, tout choc électrique ou autre blessure qui nécessitent une hospitalisation ou un traitement de longue durée en tant que patient externe.  
 \*3 : On entend par dommages sur le bien tout endommagement s'étendant aux bâtiments, aux effets mobiliers, aux animaux d'élevage et aux animaux domestiques.

**SIGNIFICATION DES SYMBOLES AFFICHÉS SUR L'UNITÉ**

	<b>AVERTISSEMENT</b> (Risque d'incendie)	Ce marquage concerne uniquement le frigorigène R32. Le type de frigorigène est inscrit sur la plaque signalétique de l'unité extérieure. Si le frigorigène est de type R32, cela signifie que cette unité utilise un frigorigène inflammable. Si le frigorigène fuit et entre en contact avec une flamme ou un élément de chauffe, cela va générer des gaz nocifs et entraîner un risque d'incendie.
	Lisez le MANUEL D'UTILISATION attentivement avant l'utilisation.	
	Le personnel d'entretien est tenu de lire attentivement le MANUEL D'UTILISATION et le MANUEL D'INSTALLATION avant l'utilisation.	
	Des informations supplémentaires sont disponibles dans le MANUEL D'UTILISATION, le MANUEL D'INSTALLATION et autres manuels similaires.	



## ■ Avertissements apposés sur le climatiseur

Indication d'avertissement		Description
	<p><b>WARNING</b></p> <p><b>ELECTRICAL SHOCK HAZARD</b> Disconnect all remote electric power supplies before servicing.</p>	<p><b>AVERTISSEMENT</b></p> <p><b>RISQUE DE CHOC ÉLECTRIQUE</b> Débranchez toutes les alimentations électriques distantes avant l'entretien.</p>
	<p><b>WARNING</b></p> <p>Moving parts. Do not operate unit with grille removed. Stop the unit before the servicing.</p>	<p><b>AVERTISSEMENT</b></p> <p>Pièces mobiles. Ne faites pas fonctionner l'unité avec la grille retirée. Arrêtez l'unité avant l'entretien.</p>
	<p><b>CAUTION</b></p> <p>High temperature parts. You might get burned when removing this panel.</p>	<p><b>ATTENTION</b></p> <p>Pièces à température élevée. Vous pourriez vous brûler en retirant ce panneau.</p>
	<p><b>CAUTION</b></p> <p>Do not touch the aluminum fins of the unit. Doing so may result in injury.</p>	<p><b>ATTENTION</b></p> <p>Ne touchez pas les palmes en aluminium de l'unité. Vous pourriez vous blesser.</p>
	<p><b>CAUTION</b></p> <p><b>BURST HAZARD</b> Open the service valves before the operation, otherwise there might be the burst.</p>	<p><b>ATTENTION</b></p> <p><b>RISQUE D'EXPLOSION</b> Ouvrez les soupapes de service avant l'opération, sinon une explosion pourrait se produire.</p>

# 1 Précautions relatives à la sécurité

Le fabricant n'assume aucune responsabilité quant aux dommages causés par le non-respect des instructions de ce manuel.

## AVERTISSEMENT

### Généralités

- Avant d'installer le climatiseur, lisez attentivement le manuel d'installation et suivez les instructions pour installer le climatiseur.
- Seul un installateur qualifié ou un technicien d'entretien qualifié est autorisé à procéder à l'installation. Une installation inadéquate peut entraîner une fuite d'eau, un choc électrique ou un incendie.
- N'utilisez pas un réfrigérant différent de celui spécifié pour le complément ou le remplacement. Sinon, une pression anormalement élevée risque d'être générée dans le circuit de réfrigération, ce qui peut entraîner une panne ou une explosion du produit ou vous pouvez vous blesser.
- Avant d'ouvrir la grille d'entrée d'air de l'unité intérieure ou du panneau de service de l'unité extérieure, réglez le disjoncteur sur la position OFF. Ne pas régler le disjoncteur sur la position OFF peut entraîner un choc électrique par le biais d'un contact avec les pièces intérieures. Seul un installateur qualifié (\*1) ou un technicien d'entretien qualifié (\*1) est autorisé à enlever la grille d'entrée d'air de l'unité intérieure ou le panneau de service de l'unité extérieure et à effectuer le travail requis.
- Avant de procéder à l'installation, à l'entretien, à la réparation ou à la dépose, réglez le disjoncteur en position OFF. Dans le cas contraire, cela peut entraîner des chocs électriques.
- Placez un panneau « Travail en cours » à proximité du disjoncteur pendant l'installation, l'entretien, la réparation ou la dépose. Un danger de choc électrique est possible si le disjoncteur est réglé sur ON par erreur.
- Seul un installateur qualifié (\*1) ou un technicien d'entretien qualifié (\*1) est autorisé à entreprendre un travail en hauteur à l'aide d'un escabeau de 50 cm ou plus pour retirer la grille d'entrée d'air de l'unité intérieure pour entreprendre le travail.
- Portez des gants de protection ainsi que des vêtements de travail de sécurité pendant l'installation, l'entretien et la dépose.
- Ne touchez pas les palmes en aluminium de l'unité. Vous risquez de vous blesser dans le cas contraire. Si vous devez toucher les palmes pour une raison quelconque, mettez d'abord des gants de protection et des vêtements de travail de sécurité, ensuite, procédez à l'opération.
- Ne grimpez pas ou ne placez pas d'objets sur le dessus de l'unité extérieure. Vous ou les objets pourriez tomber de l'unité extérieure et ainsi vous blesser.

- Lors de la réalisation d'un travail en hauteur, utilisez une échelle conforme à la norme ISO 14122 et suivez la procédure associée aux instructions de l'échelle. Portez également un casque de protection pour une utilisation dans l'industrie comme tenue de protection pour entreprendre le travail.
- Avant le nettoyage du filtre ou d'autres pièces de l'unité extérieure, réglez le disjoncteur sur OFF sans faute, et placez un panneau indicateur « Travail en cours » à proximité du disjoncteur avant de commencer le travail.
- Avant de travailler en hauteur, placez un panneau indicateur avant de commencer à travailler, afin que personne ne s'approche du lieu de travail. Des pièces et d'autres objets risquent de tomber du haut, pouvant blesser une personne se trouvant en dessous. Pendant toute la durée du travail, portez un casque, afin d'être protégé en cas de chute d'objets.
- N'utilisez pas de réfrigérant autre que le R32 ou R410A. Pour connaître le type de réfrigérant, vérifiez l'unité extérieure à combiner.
- Le climatiseur doit être transporté dans des conditions stables. Si une pièce est endommagée, contactez le revendeur.
- Si le climatiseur doit être transporté à la main, faites appel à plusieurs personnes.
- Ne déplacez ni ne réparez l'unité vous-même. L'intérieur de l'unité est sous haute tension. Vous risqueriez un choc électrique en retirant le couvercle et l'unité principale.
- Cet appareil est conçu pour être utilisé par des experts ou des utilisateurs formés dans des magasins, dans l'industrie légère ou dans le cadre d'une utilisation commerciale par des personnes non initiées.

### Sélection du lieu d'installation

- Si le climatiseur est installé dans une petite pièce, prenez les mesures qui s'imposent pour que, en cas de fuite, la teneur de la pièce en réfrigérant ne dépasse pas le seuil critique.
- N'installez pas cet appareil dans un endroit où des fuites de gaz inflammable sont possibles. En cas de fuite du gaz et d'accumulation à proximité du climatiseur, un incendie peut se déclarer.
- Lors du transport du climatiseur, portez des chaussures à coquilles de protection supplémentaires.
- Lors du transport du climatiseur, n'agrippez pas les bandes du carton d'emballage. Vous risquez de vous blesser si les bandes se brisent.
- Installez l'unité intérieure à au moins 2,5 m au dessus du niveau du sol. Dans le cas contraire, les utilisateurs peuvent se blesser ou recevoir des chocs électriques s'ils mettent leurs doigts ou un objet dans l'unité intérieure alors que le climatiseur fonctionne.
- Ne placez aucun appareil à combustion dans un endroit exposé directement au souffle du climatiseur, faute de quoi sa combustion risquerait d'être défectueuse.

- L'appareil et les tuyauteries doivent être installés, utilisés et stockés dans une pièce dont la surface de plancher est supérieure à  $A_{\min} \text{ m}^2$ .  
Comment obtenir  $A_{\min} \text{ m}^2$  :  $A_{\min} = (M / (2,5 \times 0,22759 \times h_0))^2$   
M est la quantité de charge de frigorigène dans l'appareil exprimée en **kg** ;  
 $h_0$  est la hauteur d'installation de l'appareil en **m** :  
0,6 m pour montage au sol / 1,8 m pour montage mural / 1,0 m pour montage sur fenêtre / 2,2 m pour montage au plafond.  
(Modèles de réfrigérant R32 seulement. Pour plus de détails, référez-vous au manuel d'installation de l'unité extérieure.)

### Installation

- Lorsque l'unité intérieure doit être suspendue, les tiges filetées pour suspension (M10 ou W3/8) et les écrous (M10 ou W3/8) de suspension désignés doivent être utilisés.
- Installez le climatiseur en toute sécurité sur une base capable de le supporter. Si la base n'est pas assez résistante, l'unité peut tomber et provoquer des blessures.
- Suivez les instructions du manuel d'installation pour installer le climatiseur. Le non-respect de ces instructions peut entraîner la chute ou le basculement de l'appareil, voire engendrer du bruit, des vibrations, une fuite d'eau, etc.
- Effectuez l'installation spécifiée pour protéger le climatiseur contre un tremblement de terre ou des vents violents. S'il n'est pas correctement monté, le climatiseur risque de tomber ou de basculer, ce qui peut entraîner un accident.
- Si le gaz réfrigérant a fui durant l'installation, aérez immédiatement la pièce. Si le gaz réfrigérant qui a fui entre en contact avec le feu, un gaz nocif peut se dégager.
- Utilisez un chariot élévateur pour porter le climatiseur. Pour l'élever, utilisez un treuil ou un monte-charge.

### Tuyaux de réfrigérant

- Fixez solidement le tuyau de réfrigérant pendant l'installation, avant de faire fonctionner le climatiseur. Si le compresseur est utilisé avec la vanne ouverte et sans que le tuyau de réfrigérant ne soit connecté, le compresseur aspire l'air et le circuit de réfrigération est alors en surpression. Dans ce cas, les tuyaux risquent de blesser quelqu'un.
- Serrez l'écrou évasé avec une clé dynamométrique de la manière spécifiée. Si vous appliquez un couple excessif, l'écrou risque, après un certain temps, de se casser et de provoquer une fuite de réfrigérant.
- Après l'installation, assurez-vous que le gaz réfrigérant ne fuit pas. Si le gaz réfrigérant fuit dans la pièce et s'écoule à proximité d'une source inflammable, telle qu'une cuisinière, un gaz nocif peut se dégager.

- Lorsque le climatiseur a été installé ou déplacé, suivez les instructions du manuel d'installation et purgez la totalité de l'air afin qu'aucun gaz autre que le réfrigérant ne soit mélangé dans le circuit de réfrigération. Ne pas purger complètement l'air peut entraîner un dysfonctionnement du climatiseur.
- De l'azote gazeux doit être utilisé pour l'essai d'étanchéité à l'air.
- Le tuyau de remplissage doit être raccordé de telle manière qu'il ne soit pas lâche.

### **Raccordement électrique**

- Seul un installateur qualifié (\*1) ou un technicien d'entretien qualifié (\*1) est autorisé à réaliser le travail électrique sur le climatiseur. En aucun cas, ce travail doit être effectué par une personne non qualifiée étant donné que si le travail n'est pas correctement effectué, des chocs électriques et/ou des fuites électriques peuvent survenir.
- Lors du raccordement des câbles électriques, de la réparation des pièces électriques ou de l'exécution d'autres travaux électriques, portez des gants pour vous protéger du courant, ainsi que des chaussures et des vêtements isolants pour vous protéger de chocs électriques. Ne pas porter cette tenue de protection peut entraîner des chocs électriques.
- Utilisez un câblage qui respecte les spécifications du manuel d'installation et les dispositions des réglementations et de la législation locales. L'utilisation d'un câblage qui n'est pas conforme aux spécifications peut donner lieu à des chocs électriques, une fuite électrique, de la fumée et/ou un incendie.
- Branchez le fil de terre. (Mise à la terre)  
Une mise à la terre incomplète peut provoquer une décharge électrique.
- Ne raccordez pas les fils de terre à des conduites de gaz, des conduites d'eau, un parafoudre ou des fils de terre pour câbles téléphoniques.
- Après avoir terminé le travail de réparation ou de déplacement, assurez-vous que le fil de terre est correctement raccordé.
- Installez un disjoncteur qui respecte les spécifications du manuel d'installation et les dispositions des réglementations et de la législation locales.
- Installez le disjoncteur là où il peut facilement être accessible par l'agent.
- Lors de l'installation du disjoncteur à l'extérieur, installez-en un qui soit conçu pour être utilisé à l'extérieur.
- En aucun cas le câble d'alimentation électrique ou le câble de connexion intérieur et extérieur ne doivent pas être connectés au milieu (connexion à l'aide d'une borne sans soudure etc.)  
Des problèmes de raccordement dans des endroits où le câble est connecté au milieu peuvent entraîner de la fumée et/ou un incendie.

- Le travail de câblage électrique doit être réalisé conformément à la législation et à la réglementation locales et au manuel d'installation. Dans le cas contraire, un choc électrique ou un court-circuit peut survenir.

### **Essai de fonctionnement**

- Avant de faire fonctionner le climatiseur après avoir terminé le travail, assurez-vous que le couvercle du boîtier des pièces électriques de l'unité intérieure et du panneau de service de l'unité extérieure sont fermés, ensuite, réglez le disjoncteur sur la position ON. Vous pouvez recevoir un choc électrique si l'alimentation est activée sans avoir d'abord effectué ces vérifications.
- En cas de problème au niveau du climatiseur (comme par exemple l'affichage d'un code d'erreur, une odeur de brûlé, des sons anormaux, le climatiseur qui ne parvient pas à refroidir ou à réchauffer l'air, ou une fuite d'eau), ne touchez pas le climatiseur vous-même, mais réglez le disjoncteur sur la position OFF, puis contactez un technicien d'entretien qualifié. Prenez des mesures pour garantir que l'alimentation ne sera pas branchée (en indiquant « hors service » près du disjoncteur, par exemple) jusqu'à ce que le technicien d'entretien qualifié arrive. Continuer à utiliser le climatiseur alors qu'il présente un problème peut entraîner des problèmes mécaniques ou donner lieu à des chocs électriques et autres pannes.
- Une fois le travail terminé, utilisez un contrôleur d'isolement (mégohmmètre de 500 V) afin de vérifier que la résistance est de 1 MΩ minimum entre la section de charge et la section métallique sans charge (Section terre). Si la valeur de résistance est faible, une catastrophe telle qu'une fuite ou une décharge électrique se produit sur le côté utilisateur.
- À l'issue du travail d'installation, vérifiez qu'il n'y a pas de fuites de réfrigérant et vérifiez la résistance d'isolation ainsi que l'évacuation d'eau. Ensuite, effectuez un essai de fonctionnement afin de vous assurer que le climatiseur fonctionne correctement.

### **Explications données à l'utilisateur**

- À l'issue de l'installation, indiquez à l'utilisateur l'emplacement du disjoncteur. Si l'utilisateur ne sait pas où se trouve le disjoncteur, il ne sera pas capable de le désactiver au cas où un problème surviendrait au niveau du climatiseur.
- Après le travail d'installation, reportez-vous au manuel de l'utilisateur pour expliquer au client comment utiliser l'unité et effectuer son entretien.

## Réinstallation

- Seul un installateur qualifié (\*1) ou un technicien d'entretien qualifié (\*1) est autorisé à déplacer le climatiseur. Le déplacement du climatiseur par une personne non qualifiée représente un danger étant donné qu'un incendie, un choc électrique, des blessures, des fuites d'eau, du bruit et/ou des vibrations peuvent en résulter.
- Lors de la réalisation du travail de pompage, coupez le compresseur avant de débrancher le tuyau de réfrigérant. Débrancher le tuyau de réfrigérant alors que la vanne d'entretien est restée ouverte et que le compresseur fonctionne encore peut entraîner une aspiration de l'air ou d'autre gaz, faisant augmenter la pression à l'intérieure du circuit de réfrigération à un niveau anormalement élevé, et pouvant donner lieu à un éclatement, un dommage ou d'autres problèmes.

## ATTENTION

**Ce climatiseur utilise un frigorigène HFC (R32 ou R410A) qui ne détruit pas la couche d'ozone.**

- Le frigorigène R32 ou R410A est facilement affecté par les impuretés telles que l'humidité, un film oxydé, l'huile, etc., en raison d'une pression élevée, c'est pourquoi il faut faire attention de ne pas laisser l'humidité, la poussière, l'huile de la machine frigorifique, le frigorigène existant, etc., se mélanger au cycle de réfrigération pendant les travaux d'installation.
- Un outil spécial pour le frigorigène R32 ou R410A est nécessaire pour l'installation.
- Utilisez un matériau de tuyauterie neuf et propre pour le tuyau de raccordement afin que l'humidité et la saleté ne se mélangent pas pendant les travaux d'installation.
- Lors de l'utilisation de tuyaux existants, suivez les instructions d'installation indiquées dans le manuel d'installation fourni avec l'unité extérieure.

(\*1) Reportez-vous à « Définition d'un installateur qualifié ou d'un technicien d'entretien qualifié ».

Vielen Dank, dass Sie sich für ein Klimagerät von Toshiba entschieden haben.  
Bitte lesen Sie diese Anleitung, die wichtige Informationen gemäß der „Maschinenrichtlinie“ (Richtlinie 2006/42/EG) enthält, aufmerksam durch und klären Sie eventuelle Fragen.  
Geben Sie nach Abschluss der Installation dieses Installationshandbuch und die Bedienungsanleitung dem Benutzer und bitten Sie ihn, diese zu Informationszwecken an einem sicheren Ort aufzubewahren.

**Allgemeine Bezeichnung: Klimaanlage**

**Definition der Bezeichnungen „Qualifizierter Installateur“ oder „Qualifizierter Servicetechniker“**

Die Klimaanlage muss von einem qualifizierten Installateur oder einem qualifizierten Servicetechniker installiert, gewartet, repariert und entsorgt werden. Wenn eine dieser Aufgaben erledigt werden muss, bitten Sie einen qualifizierten Installateur oder einen qualifizierten Servicetechniker, diese für Sie auszuführen.  
Ein qualifizierter Installateur oder ein qualifizierter Servicetechniker ist ein Auftragnehmer, der über die Qualifikationen und das Fachwissen verfügt, welche in der untenstehenden Tabelle genannt sind.



Auftragnehmer	Qualifikationen und Fachwissen, über welche der Auftragnehmer verfügen muss
Qualifizierter Installateur	<ul style="list-style-type: none"> <li>Der Installationsfachmann ist eine Person, die Klimageräte der Toshiba Carrier Corporation einbaut, wartet, umzieht und ausbaut. Die Person ist im Einbau und in der Wartung sowie im Umzug und Ausbau von Klimageräten der Toshiba Carrier Corporation geschult oder wurde von einer geschulten Person oder geschulten Personen unterwiesen und verfügt aufgrund dessen über gründliche Kenntnisse, die sie zur Ausführung dieser Arbeiten befähigt.</li> <li>Der Installationsfachmann, dem es erlaubt ist, Elektroarbeiten im Zuge des Einbaus, Umzugs oder Ausbaus auszuführen, verfügt über die jeweils gesetzlich vorgeschriebene Qualifikation zur Ausführung von Elektroarbeiten und ist eine Person, die im Zusammenhang mit Elektroarbeiten an Klimageräten der Toshiba Carrier Corporation geschult ist oder in diesem Zusammenhang von einer geschulten Person oder geschulten Personen unterwiesen wurde, so dass sie über gründliche Kenntnisse verfügt, die sie zur Ausführung dieser Arbeiten befähigt.</li> <li>Der Installationsfachmann, dem es erlaubt ist, Kältemittel- oder rohrtechnische Arbeiten im Zuge des Einbaus, Umzugs oder Ausbaus auszuführen, verfügt über die jeweils gesetzlich vorgeschriebene Qualifikation zur Ausführung von Kältemittel- und rohrtechnischen Arbeiten und ist eine Person, die im Zusammenhang mit Kältemittel- und rohrtechnischen Arbeiten an Klimageräten der Toshiba Carrier Corporation geschult ist oder in diesem Zusammenhang von einer geschulten Person oder geschulten Personen unterwiesen wurde, so dass sie über gründliche Kenntnisse verfügt, die sie zur Ausführung dieser Arbeiten befähigt.</li> <li>Der Installationsfachmann, dem es erlaubt ist, Arbeiten in der Höhe auszuführen, ist im Zusammenhang mit Arbeiten in der Höhe an Klimageräten der Toshiba Carrier Corporation geschult oder wurde in diesem Zusammenhang von einer geschulten Person oder geschulten Personen unterwiesen und verfügt aufgrund dessen über gründliche Kenntnisse, die ihn zur Ausführung dieser Arbeiten befähigt.</li> </ul>
Qualifizierter Servicetechniker	<ul style="list-style-type: none"> <li>Der Installationsfachmann ist eine Person, die Klimageräte der Toshiba Carrier Corporation repariert, einbaut, wartet, umzieht und ausbaut. Die Person ist im Einbau und in der Reparatur und Wartung sowie im Umzug und Ausbau von Klimageräten der Toshiba Carrier Corporation geschult oder wurde von einer geschulten Person oder geschulten Personen unterwiesen und verfügt aufgrund dessen über gründliche Kenntnisse, die sie zur Ausführung dieser Arbeiten befähigt.</li> <li>Der Installationsfachmann, dem es erlaubt ist, Elektroarbeiten im Zuge des Einbaus, der Reparatur, des Umzugs oder Ausbaus auszuführen, verfügt über die jeweils gesetzlich vorgeschriebene Qualifikation zur Ausführung von Elektroarbeiten und ist eine Person, die im Zusammenhang mit Elektroarbeiten an Klimageräten der Toshiba Carrier Corporation geschult ist oder in diesem Zusammenhang von einer geschulten Person oder geschulten Personen unterwiesen wurde, so dass sie über gründliche Kenntnisse verfügt, die sie zur Ausführung dieser Arbeiten befähigt.</li> <li>Der Installationsfachmann, dem es erlaubt ist, Kältemittel- oder rohrtechnische Arbeiten im Zuge des Einbaus, der Reparatur, des Umzugs oder Ausbaus auszuführen, verfügt über die jeweils gesetzlich vorgeschriebene Qualifikation zur Ausführung von Kältemittel- und rohrtechnischen Arbeiten und ist eine Person, die im Zusammenhang mit Kältemittel- und rohrtechnischen Arbeiten an Klimageräten der Toshiba Carrier Corporation geschult ist oder in diesem Zusammenhang von einer geschulten Person oder geschulten Personen unterwiesen wurde, so dass sie über gründliche Kenntnisse verfügt, die sie zur Ausführung dieser Arbeiten befähigt.</li> <li>Der Installationsfachmann, dem es erlaubt ist, Arbeiten in der Höhe auszuführen, ist im Zusammenhang mit Arbeiten in der Höhe an Klimageräten der Toshiba Carrier Corporation geschult oder wurde in diesem Zusammenhang von einer geschulten Person oder geschulten Personen unterwiesen und verfügt aufgrund dessen über gründliche Kenntnisse, die ihn zur Ausführung dieser Arbeiten befähigt.</li> </ul>

**Definitionen zur Schutzkleidung**

Bei Transport, Einbau, Wartung, Reparatur und Ausbau des Klimageräts sind Schutzhandschuhe und Sicherheitsarbeitskleidung zu tragen.  
Neben dieser normalen Schutzausrüstung wird für die in der Tabelle unten aufgeführten Spezialarbeiten die jeweils genannte Schutzausrüstung benötigt.  
Wer auf die korrekte Schutzausrüstung verzichtet, geht ein hohes Risiko ein, denn die Ausrüstung schützt vor Verletzungen, Verbrennungen, Stromschlag und anderen Gefahren.





Arbeitsaufgabe	Zu tragende Schutzkleidung
Alle Arten von Arbeiten	Schutzhandschuhe Sicherheitsarbeitskleidung
Elektroarbeiten	Isolierhandschuhe zum Schutz vor Stromschlägen Isolierschuhe Arbeitskleidung, die Schutz vor Stromschlägen bietet
Arbeiten in der Höhe (50 cm und höher)	Industrie-Schutzhelme
Transport schwerer Gegenstände	Schuhe mit Zehenschutzkappen
Reparatur des Außengeräts	Isolierhandschuhe zum Schutz vor Stromschlägen

Diese Vorsichtsmaßregeln zur Sicherheit beschreiben wichtige Fragen zur Sicherheit, um Verletzungen der Benutzer und anderer Personen ebenso wie Sachschäden zu vermeiden. Bitte lesen Sie dieses Handbuch gründlich durch, nachdem Sie sich mit den untenstehenden Inhalten (den Bedeutungen der Anzeigen) vertraut gemacht haben, und folgen Sie immer der Beschreibung.





Anzeige	Bedeutung der Anzeige
 <b>WARNUNG</b>	Auf diese Weise gekennzeichnete Text weist darauf hin, dass die Nichteinhaltung der Anweisungen in der Warnung zu schweren Körperverletzungen (*1), möglicherweise mit Todesfolge, führen kann, wenn das Produkt nicht ordnungsgemäß verwendet wird.
 <b>VORSICHT</b>	Auf diese Weise gekennzeichnete Text weist darauf hin, dass die Nichteinhaltung der Anweisungen in der Warnung zu schweren Körperverletzungen (*2) oder Sachschäden (*3) führen kann, wenn das Produkt nicht ordnungsgemäß verwendet wird.

\*1: Schwere Körperverletzung beinhaltet Verlust der Sehkraft, Verletzungen, Verbrennungen, Stromschlag, Knochenbrüche, Vergiftungen und andere Verletzungen, die Nachwirkungen hinterlassen und Krankenhausaufenthalt oder lange ambulante Behandlung erfordern.  
\*2: Leichte Körperverletzung beinhaltet Verletzungen, Verbrennungen, Stromschlag und andere Verletzungen, die keinen Krankenhausaufenthalt bzw. keine langfristige ambulante Behandlung erfordern.  
\*3: Sachschäden beinhaltet Schäden an Gebäuden, Hausrat, Nutztieren und Haustieren.

**BEDEUTUNG DER AUF DEM GERÄT ANGEZEIGTEN SYMBOLE**

	<b>WARNUNG</b> (Feueregefahr)	Dieses Symbol gilt nur für das Kältemittel R32. Der Kältemitteltyp ist auf dem Typenschild des Außengeräts vermerkt. Im Falle, dass das Kältemittel R32 vermerkt ist, verwendet dieses Gerät ein brennbares Kältemittel. Wenn das Kältemittel austritt und in Kontakt mit einer Zündquelle oder einem heißen Gegenstand gerät, erzeugt es ein gefährliches Gas und es besteht Feueregefahr.
	Lesen Sie die <b>BEDIENUNGSANLEITUNG</b> gründlich durch, bevor Sie das Gerät in Betrieb nehmen.	
	Das Servicepersonal muss die <b>BEDIENUNGSANLEITUNG</b> und die <b>INSTALLATIONSANLEITUNG</b> gründlich durchlesen, bevor es das Gerät in Betrieb nimmt.	
	Ausführliche Informationen finden Sie in der <b>BEDIENUNGSANLEITUNG</b> , <b>INSTALLATIONSANLEITUNG</b> usw.	

## ■ Warnhinweise am Klimagerät

Warnanzeige		Beschreibung
 <p><b>WARNING</b> <b>ELECTRICAL SHOCK HAZARD</b> Disconnect all remote electric power supplies before servicing.</p>	<p><b>WARNUNG</b> <b>GEFAHR EINES ELEKTRISCHEN SCHLAGS</b> Trennen Sie alle fernen Stromversorgungsquellen vom Netz, bevor Sie Wartungsarbeiten ausführen.</p>	
 <p><b>WARNING</b> Moving parts. Do not operate unit with grille removed. Stop the unit before the servicing.</p>	<p><b>WARNUNG</b> Bewegliche Teile. Bedienen Sie nicht das Gerät, wenn das Gitter entfernt wurde. Stoppen Sie das Gerät, bevor Sie es warten.</p>	
 <p><b>CAUTION</b> High temperature parts. You might get burned when removing this panel.</p>	<p><b>VORSICHT</b> Teile mit hohen Temperaturen. Es besteht die Gefahr, dass Sie sich verbrennen, wenn Sie diese Abdeckung entfernen.</p>	
 <p><b>CAUTION</b> Do not touch the aluminum fins of the unit. Doing so may result in injury.</p>	<p><b>VORSICHT</b> Die Aluminiumlamellen des Geräts nicht berühren. Dies kann zu Verletzungen führen.</p>	
 <p><b>CAUTION</b> <b>BURST HAZARD</b> Open the service valves before the operation, otherwise there might be the burst.</p>	<p><b>VORSICHT</b> <b>EXPLOSIONSGEFAHR!</b> Öffnen Sie vor dem Arbeitsgang die Versorgungsventile, da es anderenfalls zu einer Explosion kommen kann.</p>	

# 1 Vorsichtsmaßnahmen für die Sicherheit

Der Hersteller übernimmt keinerlei Haftung für durch Nichtbeachtung der Beschreibungen in diesem Handbuch entstandene Schäden.

## **WARNUNG**

### Allgemeines

- Bevor Sie mit der Installation des Klimageräts beginnen, lesen Sie das Installationshandbuch sorgfältig durch und befolgen Sie die darin enthaltenen Anweisungen zum Installieren des Klimageräts.
- Die Installationsarbeiten dürfen nur von qualifiziertem Installations- oder Servicepersonal durchgeführt werden. Eine nicht fachgerechte Installation kann zum Austritt von Wasser sowie zu Stromschlägen oder Brand führen.
- Verwenden Sie ausschließlich das zur Ergänzung oder als Ersatz angegebene Kühlmittel. Andernfalls kann im Kühlkreislauf ein abnormal hoher Druck entstehen, der eine Fehlfunktion oder Explosion des Produkts oder Verletzungen zur Folge haben kann.
- Bevor Sie das Einlassgitter des Innengerätes oder das Wartungspaneel des Außengeräts öffnen, stellen Sie den Schutzschalter auf die Position OFF (aus). Sollten Sie diesen Hinweis nicht beachten, kann es durch Kontakt mit den Innenteilen zu einem Stromschlag kommen. Nur ein qualifizierter Installateur (\*1) oder ein qualifizierter Servicetechniker (\*1) darf das Einlassgitter des Innengeräts oder das Wartungspaneel des Außengeräts entfernen und die erforderlichen Arbeiten ausführen.
- Bevor Sie mit den Installations-, Wartungs-, Reparatur- oder Deinstallationsarbeiten beginnen, schalten Sie den Hauptschalter in die Stellung OFF (aus). Andernfalls kann es zu elektrischen Schlägen kommen.
- Befestigen Sie ein Schild „Arbeiten in Ausführung“ neben dem Schutzschalter, während die Installations-, Wartungs-, Reparatur- oder Entsorgungsarbeiten ausgeführt werden. Es besteht die Gefahr von Stromschlägen, wenn der Schutzschalter aus Versehen auf ON (ein) gestellt wird.
- Nur ein qualifizierter Installateur (\*1) oder ein qualifizierter Servicetechniker (\*1) darf Höhenarbeiten unter Verwendung eines 50 cm hohen oder noch höheren Ständers ausführen oder das Einlassgitter des Innengeräts entfernen und die erforderlichen Arbeiten ausführen.
- Tragen Sie bei Installation, Wartung und Entsorgung Schutzhandschuhe und Arbeitsschutzbekleidung.
- Die Aluminiumlamelle des Geräts nicht berühren. Andernfalls können Sie sich verletzen. Wenn die Rippen aus einem bestimmten Grund berührt werden muss, ziehen Sie zuerst Schutzhandschuhe und Arbeitsschutzbekleidung an, bevor Sie diese Arbeiten ausführen.
- Klettern Sie nicht auf das Außengerät, und stellen Sie keine Gegenstände darauf ab. Andernfalls können Sie abstürzen, oder Gegenstände können herunterfallen. In beiden Fällen besteht Verletzungsgefahr.

- Wenn Sie Höhenarbeiten ausführen, verwenden Sie eine Leiter gemäß ISO-Norm 14122 und befolgen Sie die in der Anleitung der Leiter aufgeführten Anweisungen. Tragen Sie als Schutzkleidung beim Ausführen der Arbeiten außerdem einen Industrie-Schutzhelm.
- Bevor Sie den Filter oder andere Teile des Außengeräts reinigen, stellen Sie unbedingt den Schutzschalter auf OFF (aus), und befestigen Sie ein Schild „Laufende Arbeiten“ neben dem Schutzschalter, bevor Sie die Arbeiten ausführen.
- Bevor Sie Höhenarbeiten ausführen, stellen Sie ein Warnschild auf, damit sich niemand dem Arbeitsbereich nähert. Teile und andere Gegenstände können von oben herunterfallen und u. U. unten befindliche Personen verletzen. Tragen Sie während der Arbeit einen Helm zum Schutz vor herabfallenden Objekten.
- Verwenden Sie kein anderes Kältemittel als R32 oder R410A. Überprüfen Sie das zu kombinierende Außengerät wegen des Kältemitteltyps.
- Die Klimaanlage muss in einem stabilen Zustand transportiert werden. Setzen Sie sich mit Ihrem Fachhändler in Verbindung, falls Sie feststellen sollten, dass ein Teil des Produkts defekt ist.
- Falls die Klimaanlage von Hand transportiert wird, muss von mindestens zwei Personen getragen werden.
- Versuchen Sie unter keinen Umständen, eines der Geräte selbst auszubauen bzw. instand zu setzen. Im Geräteinneren liegt Hochspannung an. Beim Ausbau von Abdeckung und Hauptgerät besteht elektrische Berührungsfahrer.
- Dieses Gerät ist für die Nutzung durch einem Experten oder geschulte Anwender in Geschäften, in der leichten Industrie oder für Laien bei der gewerblichen Nutzung bestimmt.

### Auswahl des Installationsortes

- Wenn Sie die Klimaanlage in einem kleinen Raum installieren, treffen Sie entsprechende Vorkehrungen, damit es in dem Raum bei einem Leck nicht zu einer übermäßigen Konzentration von Kühlmitteldämpfen kommt.
- Nehmen Sie keine Installation an einem Ort vor, an dem der Austritt entflammbarer Gase möglich sein könnte. Wenn entflammbares Gas austritt und sich um das Gerät herum ansammelt, könnte es sich entzünden und einen Brand verursachen.
- Tragen Sie beim Transportieren der Klimaanlage Schuhe mit Zehenschutzkappen.
- Halten Sie die Klimaanlage beim Tragen nicht an den Bändern des Verpackungskartons fest. Anderenfalls können Sie sich verletzen, wenn die Bänder reißen.
- Installieren Sie das Innengerät mindestens 2,5 m über dem Boden, da sich Personen anderenfalls verletzen oder Stromschläge erleiden können, falls sie ihre Finger oder andere Gegenstände in das Innengerät stecken, während die Klimaanlage läuft.
- Stellen Sie keine Verbrennungsvorrichtung an Orten auf, wo sie direkt dem Wind der Klimaanlage ausgesetzt ist, da anderenfalls eine unvollständige Verbrennung die Folge ist.

- Das Gerät und die Rohrleitungen sind in einem Raum zu installieren, zu betreiben und zu lagern, dessen Raumfläche größer als  $A_{\min} \text{ m}^2$  ist. So berechnen Sie  $A_{\min} \text{ m}^2$ :  $A_{\min} = (M / (2,5 \times 0,22759 \times h_0))^2$   
M ist die Füllmenge des Kältemittels im Gerät in **kg**;  
 $h_0$  ist die Installationshöhe des Geräts in **m**:  
0,6 m bei Aufstellung auf dem Fußboden / 1,8 m bei Montage an einer Wand / 1,0 m bei Montage an einem Fenster / 2,2 m bei Montage an der Decke.  
(Nur für Modelle mit Kältemittel R32. Ausführliche Informationen finden Sie in der Installationsanleitung des Außengeräts.)

### Installation

- Wenn das Innengerät aufgehängt werden soll, müssen die angegebenen Hängeschrauben (M10 oder W3/8) und Muttern (M10 oder W3/8) verwendet werden.
- Installieren Sie die Klimaanlage sicher an einer Stelle, die für das Gewicht des Geräts geeignet ist. Ist der Boden nicht widerstandsfähig genug, kann das Gerät umkippen und Verletzungen verursachen.
- Installieren Sie die Klimaanlage entsprechend den Anweisungen im Installationshandbuch. Bei Missachtung dieser Anweisungen kann das Gerät hinunterfallen, umkippen oder Geräusche, Vibrationen, Wasseraustritte oder andere Probleme verursachen.
- Falls Sie in einem windanfälligen oder erdbebengefährdeten Gebiet leben, achten Sie bei der Installation auf eine entsprechende Auslegung der Befestigung. Wenn die Klimaanlage nicht ordnungsgemäß installiert wird, kann das Gerät umkippen oder hinunterfallen und so einen Unfall verursachen.
- Ist während der Installation Kühlmittel ausgetreten, lüften Sie den Raum umgehend. Kommen Kühlmitteldämpfe in Kontakt mit Feuer, können sich gesundheitsschädliche Gase bilden.
- Verwenden Sie für den Transport der Klimaanlage einen Gabelstapler sowie eine Winde oder einen Flaschenzug bei der Installation.

### Kühlmittleitungen

- Überprüfen Sie die sichere Installation der Kühlmittleitung, bevor Sie die Klimaanlage in Betrieb nehmen. Falls der Kompressor bei geöffnetem Ventil und ohne Kühlmittelrohr betrieben wird, saugt er Luft ein und der Gasdruck im Kühlkreislauf wird extrem hoch, was zu einer Verletzung führen kann.
- Ziehen Sie die Bördelmutter mit einem Drehmomentschlüssel wie angegeben fest. Übermäßiges Festziehen der Bördelmutter kann nach längerer Zeit zu Rissen in der Bördelmutter führen, wodurch Kühlmittel auslaufen kann.
- Vergewissern Sie sich daher nach der Installation noch einmal, dass kein Kühlmittel austreten kann. Wenn Kühlmittelgase austreten und in einen Raum mit einem Herd oder Ofen gelangen, kann es bei einer offenen Flamme zur Bildung von gesundheitsschädlichen Gasen kommen.

- Wenn die Klimaanlage installiert oder umgesetzt wurde, führen Sie gemäß den Anweisungen im Installationshandbuch eine vollständige Luftspülung aus, so dass lediglich das Kühlmittel im Kühlkreislauf gemischt wird. Wird keine vollständige Luftspülung ausgeführt, können Fehlfunktionen der Klimaanlage auftreten.
- Für die Luftdichtepfung muss Stickstoff verwendet werden.
- Der Zuleitungsschlauch muss so angeschlossen werden, dass er nicht durchhängt.

### **Elektrische Verdrahtung**

- Nur ein qualifizierter Installateur (\*1) oder ein qualifizierter Servicetechniker (\*1) darf Elektroarbeiten an der Klimaanlage ausführen. Unter keinen Umständen dürfen diese Arbeiten von unqualifizierten Mitarbeitern ausgeführt werden, da eine nicht sachgemäße Ausführung der Arbeit zu elektrischen Schlägen und/oder Kriechströmen führen kann.
- Tragen Sie beim Anschließen von elektrischen Drähten, Reparieren von elektrischen Teilen oder Ausführen anderer Elektroarbeiten Isolierhandschuhe zum Schutz vor Stromschlägen, isolierendes Schuhwerk sowie Arbeitsschutzkleidung zum Schutz vor Stromschlägen. Falls keine Schutzkleidung getragen wird, kann es zu elektrischen Schlägen kommen.
- Beachten Sie beim Legen von elektrischen Leitungen die Spezifikationen im Installationshandbuch sowie die Bestimmungen der lokalen Gesetze und die Rechtsvorschriften. Bei Verwendung von Kabeln, die die Spezifikationen nicht erfüllen, kann es zu Stromschlägen, Kriechströmen, Rauchentwicklungen und/oder Bränden kommen.
- Schließen Sie das Erdungskabel an. (Erdungsarbeiten)  
Eine ungenügende Erdung kann einen Stromschlag verursachen.
- Schließen Sie die Erdungskabel nie an Gas- oder Wasserleitungen, Blitzableiter oder Erdungskabel von Telefonkabeln an.
- Prüfen Sie nach Abschluss der Reparatur- oder Umsetzungsarbeiten, ob die Erdungsleiter korrekt angeschlossen sind.
- Installieren Sie einen Schutzschalter, der die Spezifikationen im Installationshandbuch sowie die Bestimmungen der lokalen Gesetze und die Rechtsvorschriften erfüllt.
- Bringen Sie den Schutzschalter an einem Ort an, wo er vom Bediener problemlos erreicht werden kann.
- Wenn der Schutzschalter im Freien installiert werden soll, verwenden Sie einen Outdoor-Schutzschalter.
- Unter keinen Umständen darf die Stromleitung oder die Anschlussleitung des Innengeräts und Außengeräts in der Mitte angeschlossen werden (Anschluss an einem lötfreien Anschluss usw.)  
Ein Anschlussfehler, der dadurch entsteht, dass die Leitung in der Mitte angeschlossen wurde, kann zu Rauchbildung und/oder einem Brand führen.

- Alle elektrischen Arbeiten sind nach geltender Vorschrift und unter Beachtung des Installationshandbuchs auszuführen.  
Es besteht Stromschlag- und Kurzschlussgefahr.

### **Testlauf**

- Bevor Sie die Klimaanlage nach Abschluss der Arbeiten betreiben, stellen Sie sicher, dass die Abdeckung des Stromkastens am Innengerät und das Wartungspaneel des Außengeräts geschlossen sind, und stellen Sie den Schutzschalter auf die Position ON (ein). Sie können einen elektrischen Schlag erleiden, falls der Strom eingeschaltet wird, ohne dass Sie vorher diese Prüfungen durchgeführt haben.
- Falls Probleme mit der Klimaanlage auftreten (z. B. ein Fehler wird angezeigt, es riecht verbrannt, ungewöhnliche Geräusche sind zu hören, die Klimaanlage kühlt bzw. heizt nicht oder Wasser läuft aus), suchen Sie nicht selbst nach der Ursache, sondern stellen Sie den Schutzschalter auf die Position OFF (aus) und wenden Sie sich an einen Servicetechniker. Stellen Sie sicher, dass der Strom nicht wieder eingeschaltet wird (indem Sie beispielsweise den Schutzschalter durch „außer Betrieb“ kennzeichnen), bis ein qualifizierter Servicetechniker eintrifft. Die weitere Verwendung der Klimaanlage in fehlerhaftem Zustand kann zur Verschlimmerung der mechanischen Probleme oder zu elektrischen Schlägen und anderen Problemen führen.
- Nachdem die Arbeiten abgeschlossen wurden, überprüfen Sie mit einem Isolationsprüfgerät (500 V Megger-Tester), dass der Widerstand zwischen dem geladenen Teil und dem nichtgeladenen Metallteil (Erdungsbereich) 1 MΩ oder mehr beträgt. Falls der Widerstandswert zu niedrig ist, können an der Benutzerseite Kriechströme oder Stromschläge verursacht werden.
- Stellen Sie nach Abschluss der Installationsarbeiten sicher, dass kein Kühlmittel ausläuft, und prüfen Sie Isolierwiderstand sowie Wasserableitung. Führen Sie danach einen Testlauf durch, um sicherzustellen, dass die Klimaanlage ordnungsgemäß funktioniert.

### **Dem Benutzer mitzuteilende Informationen**

- Teilen Sie dem Benutzer nach Abschluss der Installationsarbeiten mit, wo sich der Schutzschalter befindet. Sollte der Benutzer nicht wissen, wo sich der Schutzschalter befindet, kann er diesen nicht ausschalten, falls Probleme mit der Klimaanlage auftreten.
- Befolgen Sie nach den Installationsarbeiten die Bedienungsanleitung, um dem Kunden zu erklären, wie das Gerät verwendet und gewartet wird.



---

## Umsetzung

- Nur ein qualifizierter Installateur (\*1) oder ein qualifizierter Servicetechniker (\*1) darf die Klimaanlage umsetzen. Es ist gefährlich, wenn die Klimaanlage durch einen nicht qualifizierten Benutzer umgesetzt wird, da es zu Bränden, elektrischen Schlägen, Verletzungen, Wasseraustritten, Geräuschen und/oder Vibrationen kommen kann.
  - Schließen Sie beim Durchführen der Abpumparbeiten zuerst den Kompressor, bevor Sie das Kühlmittelrohr trennen. Wenn die Kältemittelleitung bei offenem Wartungsventil abgetrennt wird und der Kompressor noch läuft, werden Luft oder andere Gase angesaugt. Der Druck im Kältemittelkreislauf steigt, und es besteht die Gefahr eines Leitungsbruchs und dementsprechend die Gefahr von Verletzungen und anderen Störungen.
- 

---

## VORSICHT

**Diese Klimaanlage verwendet ein HFC-Kältemittel (R32 oder R410A), das die Ozonschicht nicht angreift.**

- Da das R32- oder R410A-Kältemittel aufgrund des hohen Drucks leicht durch Verunreinigungen wie zum Beispiel Feuchtigkeit, einer Oxidationsschicht, Öl usw. in Mitleidenschaft gezogen wird, achten Sie sorgfältig darauf, dass bei den Installationsarbeiten keine Feuchtigkeit, kein Schmutz, verbrauchtes Kältemittel, Kältemaschinenöl usw. in den Kältemittelkreislauf eindringt.
  - Für die Installation des Kältemittels R32 oder R410A ist ein Spezialwerkzeug erforderlich.
  - Verwenden Sie für das Anschließen der Rohre neue und saubere Leitungen, sodass das Kältemittel während der Installationsarbeiten nicht mit Wasser und Schmutz verunreinigt wird.
  - Wenn Sie die vorhandenen Leitungen verwenden, befolgen Sie die dem Außengerät beigefügte Installationsanleitung.
- 

(\*1) Siehe „Definition der Bezeichnungen „Qualifizierter Installateur“ oder „Qualifizierter Servicetechniker““.

Grazie per aver acquistato questo condizionatore d'aria Toshiba.

Si prega di leggere attentamente queste istruzioni perché contengono informazioni importanti sulla conformità alla direttiva "Macchinari" (Direttiva 2006/42/CE).

Al completamento dell'installazione, consegnare all'utente il presente Manuale d'installazione e il Manuale d'uso forniti con l'unità esterna e chiedere all'utente di conservarli in un luogo sicuro per eventuali consultazioni future.

**Denominazione generica: Condizionatore d'aria**

**Definizione di installatore qualificato o tecnico dell'assistenza qualificato**

Il condizionatore d'aria deve essere installato, sottoposto a manutenzione, riparato e rimosso da un installatore qualificato o da un tecnico dell'assistenza qualificato. Quando deve essere eseguito uno di questi lavori, rivolgersi a un installatore qualificato o a un tecnico dell'assistenza qualificato per svolgerli in propria vece.

Un installatore qualificato o un tecnico dell'assistenza qualificato è un agente che dispone delle qualifiche e dell'esperienza descritti nella tabella seguente.

Agente	Qualifiche ed esperienza di cui deve disporre l'agente
Installatore qualificato	<ul style="list-style-type: none"> <li>L'installatore qualificato è una persona che installa, effettua la manutenzione, sposta e rimuove i condizionatori d'aria costruiti da Toshiba Carrier Corporation. Ha ricevuto la formazione necessaria per installare, mantenere, spostare e rimuovere i condizionatori d'aria costruiti da Toshiba Carrier Corporation o, in alternativa, è stato addestrato da uno o più individui in possesso della necessaria formazione, ed è pertanto idoneo a svolgere tali operazioni.</li> <li>L'installatore qualificato autorizzato a eseguire i lavori elettrici richiesti per l'installazione, il trasferimento e la rimozione del condizionatore d'aria possiede le qualifiche necessarie per svolgere tali compiti, come stabilito dalle leggi e dai regolamenti locali; è stato addestrato a lavorare sui condizionatori d'aria direttamente da Toshiba Carrier Corporation o da uno o più individui in possesso della necessaria formazione ed è pertanto idoneo a svolgere tale lavoro.</li> <li>L'installatore qualificato autorizzato a eseguire i lavori di gestione del refrigerante e di posa dei tubi richiesti per l'installazione, il trasferimento e la rimozione del condizionatore d'aria possiede le qualifiche necessarie per svolgere tali compiti, come stabilito dalle leggi e dai regolamenti locali; è stato addestrato a lavorare a svolgere i lavori di gestione del refrigerante e di posa dei tubi direttamente da Toshiba Carrier Corporation o da uno o più individui in possesso della necessaria formazione ed è pertanto idoneo a svolgere tale lavoro.</li> <li>L'installatore qualificato autorizzato a svolgere lavori in altezza ha ricevuto la formazione necessaria per effettuare tali lavori con i condizionatori d'aria costruiti da Toshiba Carrier Corporation o, in alternativa, è stato addestrato da uno o più individui in possesso della necessaria formazione, ed è pertanto idoneo a svolgere tali operazioni.</li> </ul>
Tecnico dell'assistenza qualificato	<ul style="list-style-type: none"> <li>Il tecnico dell'assistenza qualificato è una persona che installa, effettua la riparazione e la manutenzione, sposta e rimuove i condizionatori d'aria costruiti da Toshiba Carrier Corporation. Ha ricevuto la formazione necessaria per installare, riparare, mantenere, spostare e rimuovere i condizionatori d'aria costruiti da Toshiba Carrier Corporation o, in alternativa, è stato addestrato da uno o più individui in possesso della necessaria formazione, ed è pertanto idoneo a svolgere tali operazioni.</li> <li>Il tecnico dell'assistenza qualificato autorizzato a eseguire i lavori elettrici richiesti per l'installazione, la riparazione, il trasferimento e la rimozione del condizionatore d'aria possiede le qualifiche necessarie per svolgere tali compiti, come stabilito dalle leggi e dai regolamenti locali; è stato addestrato a lavorare sui condizionatori d'aria direttamente da Toshiba Carrier Corporation o da uno o più individui in possesso della necessaria formazione ed è pertanto idoneo a svolgere tale lavoro.</li> <li>Il tecnico dell'assistenza qualificato autorizzato a eseguire i lavori di gestione del refrigerante e di posa dei tubi richiesti per l'installazione, la riparazione, il trasferimento e la rimozione del condizionatore d'aria possiede le qualifiche necessarie per svolgere tali compiti, come stabilito dalle leggi e dai regolamenti locali; è stato addestrato a lavorare a svolgere i lavori di gestione del refrigerante e di posa dei tubi direttamente da Toshiba Carrier Corporation o da uno o più individui in possesso della necessaria formazione ed è pertanto idoneo a svolgere tale lavoro.</li> <li>Il tecnico dell'assistenza qualificato autorizzato a svolgere lavori in altezza ha ricevuto la formazione necessaria per effettuare tali lavori con i condizionatori d'aria costruiti da Toshiba Carrier Corporation o, in alternativa, è stato addestrato da uno o più individui in possesso della necessaria formazione, ed è pertanto idoneo a svolgere tali operazioni.</li> </ul>

**Definizione di attrezzatura protettiva**



Prima di procedere alle operazioni di trasporto, installazione, manutenzione, riparazione o rimozione del condizionatore d'aria è necessario indossare sempre guanti e abbigliamento protettivi.

In aggiunta ai normali dispositivi di protezione, indossare i dispositivi di protezione descritti di seguito, prima di procedere all'esecuzione dei lavori speciali elencati nella tabella sottostante.

La mancata osservanza di questa indicazione espone l'operatore al rischio di lesioni, ustioni, elettrocuzione, ecc.





Lavoro intrapreso	Attrezzatura protettiva indossata
Tutti i tipi di lavori	Guanti protettivi Abbigliamento protettivo da lavoro
Lavori elettrici	Guanti di protezione per elettricisti Scarpe isolanti Abbigliamento per la protezione da elettrocuzione
Lavori in altezza (50 cm o più)	Elmetti per uso industriale
Trasporto di oggetti pesanti	Scarpe con calotte protettive aggiuntive per le dita
Riparazione dell'unità esterna	Guanti di protezione per elettricisti

Le avvertenze per la sicurezza di seguito illustrate forniscono istruzioni importanti per prevenire lesioni alle persone e il danneggiamento delle cose. Si raccomanda di leggere il manuale solo dopo avere ben compreso tali avvertenze (testi).





Indicazione	Significato delle indicazioni
 <b>AVVERTENZA</b>	I richiami abbinati a questo simbolo indicano che la mancata osservanza delle istruzioni ad esso abbinato potrebbe divenire causa di lesioni personali gravi (*1) o anche fatali.
 <b>ATTENZIONE</b>	I richiami abbinati a questo simbolo indicano che la mancata osservanza delle istruzioni ad esso abbinato potrebbe divenire causa di lievi lesioni personali (*2) o di danni delle cose (*3).

- \*1: Con "lesioni personali gravi" s'intendono la perdita della vista, lesioni fisiche in generale, ustioni, scosse elettriche, fratture ossee, avvelenamento nonché altri effetti durevolmente nocivi per la salute e la necessità di ricovero ospedaliero o di terapia di lungo termine.
- \*2: Con "lievi lesioni personali" s'intendono le ustioni, le scosse elettriche e le altre lesioni fisiche generali che non richiedono ricovero ospedaliero né terapie di lungo termine.
- \*3: Con "danni alle cose" s'intendono il danneggiamento degli edifici o dell'arredamento e/o dotazione dell'abitazione nonché gli effetti nocivi sugli animali domestici e non.

**SIGNIFICATI DEI SIMBOLI VISUALIZZATI SULL'UNITÀ**

	<b>AVVERTENZA</b> (rischio di incendio)	Questo simbolo vale solo per il refrigerante R32. Il tipo di refrigerante è indicato sulla targhetta dell'unità esterna. Nel caso in cui il tipo di refrigerante sia R32, questa unità utilizza un refrigerante infiammabile. Se il refrigerante perde e viene a contatto con fiamme o una parte di riscaldamento, verranno creati gas dannosi e c'è il rischio di incendio.
		Leggere attentamente il MANUALE DELL'UTENTE prima dell'uso.
		Il personale addetto alla manutenzione è tenuto a leggere attentamente il MANUALE DELL'UTENTE e il MANUALE DI INSTALLAZIONE prima del funzionamento.
		Per maggiori informazioni consultare il MANUALE DELL'UTENTE, il MANUALE D'INSTALLAZIONE e simili.

## ■ Indicazioni di avvertimento sul condizionatore d'aria

Indicazione di avvertimento		Descrizione
	<p><b>WARNING</b></p> <p><b>ELECTRICAL SHOCK HAZARD</b> Disconnect all remote electric power supplies before servicing.</p>	<p><b>AVVERTENZA</b></p> <p><b>PERICOLO DI SCOSSA ELETTRICA</b> Scollegare tutte le fonti di alimentazione elettrica remota, prima di sottoporre a interventi di assistenza.</p>
	<p><b>WARNING</b></p> <p>Moving parts. Do not operate unit with grille removed. Stop the unit before the servicing.</p>	<p><b>AVVERTENZA</b></p> <p>Parti mobili. Non far funzionare l'unità con la griglia rimossa. Arrestare l'unità prima di sottoporla ad assistenza.</p>
	<p><b>CAUTION</b></p> <p>High temperature parts. You might get burned when removing this panel.</p>	<p><b>ATTENZIONE</b></p> <p>Parti ad alta temperatura. Quando si rimuove questo pannello sussiste il pericolo di ustione.</p>
	<p><b>CAUTION</b></p> <p>Do not touch the aluminum fins of the unit. Doing so may result in injury.</p>	<p><b>ATTENZIONE</b></p> <p>Non toccare le alette in alluminio dell'unità. In caso contrario, si potrebbero provocare lesioni personali.</p>
	<p><b>CAUTION</b></p> <p><b>BURST HAZARD</b> Open the service valves before the operation, otherwise there might be the burst.</p>	<p><b>ATTENZIONE</b></p> <p><b>PERICOLO DI SCOPPIO</b> Aprire le valvole di servizio prima dell'operazione; in caso contrario, si potrebbe verificare uno scoppio.</p>

# 1 Precauzioni per la sicurezza

Il produttore non si assume alcuna responsabilità per i danni causati dalla mancata osservazione delle descrizioni del presente manuale.

## **AVVERTENZA**

### Generali

- Prima d'iniziare l'installazione del condizionatore d'aria si raccomanda di leggere con attenzione il manuale d'installazione e di osservarne scrupolosamente ogni istruzione ivi fornita.
- Solo un installatore qualificato o un tecnico dell'assistenza qualificato sono autorizzati a installare l'unità. Se l'installazione non è stata eseguita correttamente si possono infatti verificare perdite d'acqua, scosse elettriche o un incendio.
- Per rabbocchi o sostituzioni, non utilizzare refrigeranti diversi da quello indicato. In caso contrario nel ciclo di refrigerazione si può generare una pressione eccessiva, che può generare guasti, esplosione del prodotto o pericolo per le persone.
- Prima di aprire la griglia della presa d'aria dell'unità interna o il pannello di servizio dell'unità esterna, impostare l'interruttore automatico sulla posizione OFF (spento). La mancata impostazione dell'interruttore automatico sulla posizione OFF (spento) potrebbe provocare scosse elettriche attraverso il contatto con le parti interne. Solo un installatore qualificato (\*1) o un tecnico dell'assistenza qualificato (\*1) sono autorizzati a rimuovere la griglia della presa d'aria dell'unità interna o il pannello di servizio dell'unità esterna e a svolgere il lavoro richiesto.
- Prima di effettuare i lavori di installazione, manutenzione, riparazione o rimozione, impostare l'interruttore automatico sulla posizione OFF (spento). In caso contrario, si potrebbero causare scosse elettriche.
- Sistemare un cartello con l'indicazione "Lavori in corso" in prossimità dell'interruttore automatico durante l'esecuzione di lavori di installazione, manutenzione, riparazione o rimozione. Qualora l'interruttore automatico sia impostato su ON (acceso) per errore, sussiste il pericolo di scosse elettriche.
- Solo un installatore qualificato (\*1) o un tecnico dell'assistenza qualificato (\*1) sono autorizzati a svolgere lavori in altezza utilizzando un supporto di altezza pari o superiore a 50 cm per rimuovere la griglia della presa d'aria dell'unità interna al fine dello svolgimento dei lavori.
- Durante l'installazione, la manutenzione e la rimozione, indossare guanti di protezione e indumenti da lavoro di sicurezza.
- Non toccare l'aletta in alluminio dell'unità. In caso contrario, si potrebbero provocare lesioni personali. Qualora sia necessario toccare l'aletta per qualche motivo, indossare prima guanti di protezione e indumenti da lavoro di sicurezza, quindi procedere.
- Non salire né collocare oggetti sull'unità esterna. Si potrebbe cadere o gli oggetti potrebbero cadere dall'unità esterna e provocare lesioni personali.

- Quando si lavora in altezza, utilizzare una scala conforme allo standard ISO 14122, e attenersi alla procedura indicata nelle istruzioni della scala. Inoltre, indossare un casco per uso industriale come attrezzatura di protezione per intraprendere il lavoro.
- Prima di pulire il filtro o altre parti dell'unità esterna, accertarsi di aver impostato l'interruttore sulla posizione OFF (spento) e sistemare un cartello con l'indicazione "Lavori in corso" in prossimità dell'interruttore, prima di iniziare il lavoro.
- Prima di lavorare in altezza, sistemare un cartello in modo che nessuno si avvicini alla sede dei lavori, prima di procedere con i lavori. Parti e altri oggetti potrebbero cadere dall'alto, con la possibilità di provocare lesioni personali a chi si trovi sotto. Mentre si effettuano i lavori, indossare un casco per proteggersi dalla caduta di oggetti.
- Non utilizzare refrigeranti diversi da R32 o R410A. Per il tipo di refrigerante, controllare l'unità esterna da combinare.
- Il condizionatore d'aria deve essere trasportato in condizioni stabili. Qualora una parte qualsiasi non sia integra si raccomanda di rivolgersi immediatamente al rivenditore.
- Se il condizionatore d'aria deve essere trasportato manualmente, l'operazione deve essere effettuata da due o più persone.
- Non tentare di spostare o riparare l'unità da soli. L'unità contiene componenti ad alta tensione. La rimozione del coperchio e dell'unità centrale potrebbe esporre al rischio di elettrocuzione.
- Questo apparecchio è destinato all'uso da parte di utenti esperti o addestrati all'interno di negozi del settore o per uso commerciale da parte di utenti comuni.

### Selezione della sede di installazione

- Se il condizionatore d'aria deve essere installato in un locale piccolo è necessario evitare che in caso di perdite il refrigerante raggiunga una concentrazione critica.
- Non installare in un luogo soggetto a possibili fughe di gas infiammabili. Qualora dovessero raggiungere una concentrazione elevata attorno ad esse potrebbero infatti causare un incendio.
- Per trasportare il condizionatore d'aria, indossare scarpe con calotte protettive aggiuntive per le dita.
- Per trasportare il condizionatore d'aria, non afferrare le fascette che circondano la scatola di imballaggio. Qualora le fascette si rompano, si potrebbero subire lesioni personali.
- Installare l'unità interna ad almeno 2,5 metri di altezza dal pavimento, poiché, in caso contrario, gli utenti potrebbero subire lesioni personali o scosse elettriche qualora urtino con le dita o altri oggetti l'unità interna mentre il condizionatore d'aria è in funzione.
- Non collocare apparecchi a combustione di alcun genere in luoghi che siano direttamente esposti al flusso d'aria prodotto dal condizionatore d'aria; in caso contrario, il condizionatore potrebbe provocare una combustione imperfetta.

- L'apparecchio e i tubi devono essere installati, fatti funzionare e immagazzinati in un locale con una superficie più grande di  $A_{\min} \text{ m}^2$ . Come ottenere  $A_{\min} \text{ m}^2$ :  $A_{\min} = (M / (2,5 \times 0,22759 \times h_0))^2$   
M è la quantità di carica del refrigerante nell'apparecchio in **kg**;  
 $h_0$  è l'altezza di installazione dell'apparecchio in **m**:  
0,6 m per installazione a pavimento/1,8 m per installazione a parete/  
1,0 m per installazione a finestra/2,2 m per installazione a soffitto.  
(Solo modelli con refrigerante R32. Per i dettagli, fare riferimento al Manuale di installazione dell'unità esterna.)

### Installazione

- Quando si deve montare in sospensione l'unità interna, è necessario utilizzare i bulloni di sospensione (M10 o W3/8) e i relativi dadi (M10 o W3/8) specificati.
- Il condizionatore deve essere installato in un punto in grado di sostenerne adeguatamente il peso. Qualora la resistenza non sia sufficiente, l'unità potrebbe cadere e provocare lesioni personali.
- Attenersi alle istruzioni nel Manuale d'installazione per installare il condizionatore d'aria. La mancata osservanza di queste istruzioni potrebbe infatti causare la caduta o il ribaltamento delle unità, nonché divenire causa di rumore, vibrazioni, fuoriuscite d'acqua o altri problemi.
- Effettuare l'installazione considerando l'eventuale possibilità di vento forte o di terremoti. Se il condizionatore d'aria non è installato correttamente, un'unità può ribaltarsi o cadere, causando un incidente.
- Se durante l'installazione si verifica una fuga del gas refrigerante occorre ventilare subito l'ambiente. A contatto con fiamme libere il gas refrigerante s'incendia generando sostanze nocive.
- Utilizzare un carrello elevatore per trasportare le unità del condizionatore d'aria e per la loro installazione utilizzare un argano o un paranco.

### Tubi del liquido refrigerante

- Installare il tubo del refrigerante stabilmente durante i lavori di installazione, prima di mettere in funzione il condizionatore d'aria. Se il compressore viene messo in funzione con la valvola aperta e senza il tubo del refrigerante, il compressore aspira aria e il circuito di refrigerazione raggiunge una pressione eccessiva, con la possibilità di causare lesioni personali.
- Serrare il dado svasato con una chiave torsionometrica come illustrato. Un serraggio eccessivo del dado svasato potrebbe causare delle spaccature nel lungo periodo, il che potrebbe provocare perdite di refrigerante.
- Una volta completata l'installazione è quindi di estrema importanza verificare che non vi siano perdite. Qualora si verifici una perdita di gas refrigerante in una stanza e il gas entri in contatto con delle fiamme, ad esempio in una cucina, si potrebbero generare gas tossici.

- Quando il condizionatore d'aria è stato installato o trasferito, attenersi alle istruzioni nel Manuale d'installazione e spurgare completamente l'aria in modo che nessun altro gas si mescoli al refrigerante nel circuito di refrigerazione. Qualora non si effettui lo spurgo completo dell'aria, si potrebbe provocare un malfunzionamento del condizionatore d'aria.
- Per la prova di tenuta dell'aria è necessario utilizzare gas di azoto.
- Il tubo flessibile di carico deve essere collegato in modo tale da non essere lasco.

### **Cavi elettrici**

- Solo un installatore qualificato (\*1) o un tecnico dell'assistenza qualificato (\*1) sono autorizzati a eseguire i lavori sull'impianto elettrico per il condizionatore d'aria. In nessuna circostanza tali lavori devono essere effettuati da una persona non qualificata, poiché un'esecuzione non appropriata dei lavori potrebbe provocare scosse elettriche e/o dispersioni di corrente.
- Per evitare di ricevere scosse elettriche, prima di eseguire collegamenti elettrici, riparare parti elettriche o condurre altre attività sull'impianto elettrico si raccomanda d'indossare guanti per elettricisti e scarpe e indumenti isolanti. Qualora non si indossino queste attrezzature protettive, si potrebbero provocare scosse elettriche.
- Utilizzare cablaggi che soddisfino le specifiche nel Manuale d'installazione e le direttive delle norme e nelle leggi locali. L'uso di cablaggi che non soddisfino le specifiche potrebbe provocare scosse elettriche, dispersioni di corrente, fumo e/o un incendio.
- Collegare il cavo di terra. (Cablaggio di messa a terra) Una messa a terra incompleta causa scosse elettriche.
- Non collegare i cavi di messa a terra a tubi del gas, tubi dell'acqua, conduttori dei parafulmini o a cavi di messa a terra per cablaggi telefonici.
- Dopo aver completato i lavori di riparazione o di trasferimento, verificare che i cavi elettrici di messa a terra siano collegati correttamente.
- Installare un interruttore automatico che soddisfi le specifiche nel Manuale d'installazione e le direttive delle norme e delle leggi locali.
- Installare l'interruttore automatico in una sede che sia facilmente accessibile dall'agente.
- Quando si installa l'interruttore automatico all'aperto, installarne uno progettato per l'uso per esterno.
- In nessuna circostanza, il cavo di alimentazione o il cavo di collegamento dell'unità interna ed esterna deve essere collegato nel mezzo (collegamento usando un terminale senza saldature, ecc.) Eventuali guasti al collegamento nelle sedi in cui il cavo è collegato nel mezzo possono provocare fumo e/o un incendio.

- I lavori di cablaggio elettrico devono essere effettuati in conformità alle normative vigenti e al manuale di installazione. La mancata osservanza di questa indicazione espone al rischio di elettrocuzione o cortocircuito.

### **Prova di funzionamento**

- Prima di far funzionare il condizionatore d'aria, dopo aver completato il lavoro, verificare che il coperchio della cassetta dei componenti elettrici dell'unità interna e il pannello di servizio dell'unità esterna siano chiusi, e impostare l'interruttore automatico sulla posizione ON (acceso). Qualora si accenda l'unità senza aver prima eseguito questi controlli, si potrebbe subire una scossa elettrica.
- Se si nota il verificarsi di un problema di qualche tipo con il condizionatore d'aria (ad esempio è stato visualizzato un codice di controllo, si sente odore di bruciato, si sentono suoni anomali, il condizionatore d'aria non raffredda o non riscalda, oppure è presente una perdita d'acqua), non toccare da soli il condizionatore d'aria, ma impostare l'interruttore automatico sulla posizione OFF (spento) e contattare un tecnico dell'assistenza qualificato. Adottare delle misure per assicurare che l'unità non venga accesa (ad esempio scrivendo "fuori servizio" in prossimità dell'interruttore) fino all'arrivo di un tecnico dell'assistenza qualificato. L'uso continuato del condizionatore d'aria in questa condizione anomala potrebbe divenire causa di problemi meccanici, generare scosse elettriche o causare altri problemi.
- Al termine del lavoro, utilizzare un misuratore di isolamento (Megger 500 V) per controllare che la resistenza sia 1 MΩ tra la sezione sotto carico elettrico e la sezione di metallo che non è sotto carico elettrico (sezione di terra). Qualora il valore di resistenza sia basso, potrebbe verificarsi un grave problema, quale una dispersione o una scossa elettrica, dal lato dell'utente.
- Al completamento del lavoro di installazione, controllare eventuali perdite di refrigerante e controllare la resistenza di isolamento e lo scarico dell'acqua. Quindi, eseguire un funzionamento di prova per controllare che il condizionatore d'aria funzioni correttamente.

### **Spiegazioni fornite all'utente**

- Al completamento del lavoro di installazione, comunicare all'utente dove sia situato l'interruttore automatico. Qualora l'utente non sappia dove si trovi l'interruttore automatico, non sarà in grado di disattivarlo, nell'eventualità che si verifichi un problema con il condizionatore d'aria.
- Dopo l'installazione, attenersi alle indicazioni nel manuale utente per spiegare al cliente come utilizzare ed effettuare la manutenzione dell'unità.

### Trasferimento

- Solo un installatore qualificato (\*1) o un tecnico dell'assistenza qualificato (\*1) sono autorizzati a trasferire il condizionatore d'aria. È pericoloso far trasferire il condizionatore d'aria da una persona non qualificata, in quanto si potrebbero provocare incendi, scosse elettriche, lesioni personali, perdite d'acqua, rumori e/o vibrazioni.
- Quando si eseguono lavori di svuotamento del refrigerante (Pump-down), spegnere il compressore prima di scollegare il tubo del refrigerante. Eseguendo questo scollegamento con la valvola di servizio aperta e il compressore in funzione si causerebbe l'aspirazione dell'aria o di altri gas eventualmente presenti nell'atmosfera, elevando in tal modo la pressione interna al circuito refrigerante a un livello eccessivamente alto con possibili rotture, lesioni personali o problemi di funzionamento.

### ATTENZIONE

**Questo condizionatore ha adottato un refrigerante HFC (R32 o R410A) che non distrugge lo strato di ozono.**

- Dato che il refrigerante R32 o R410A è facilmente influenzato da impurità, come umidità, patina ossidata, olio, ecc., a causa dell'alta pressione, fare attenzione a non permettere che umidità, sporco, refrigerante esistente, olio refrigerante per macchina, ecc., si mescolino nel ciclo del refrigerante durante il lavoro di installazione.
- Un utensile speciale per il refrigerante R32 o R410A è necessario per l'installazione.
- Utilizzare materiali di tubazione nuovi e puliti per il tubo di collegamento, in modo che umidità e sporco non vengano mescolati insieme durante il lavoro di installazione.
- Quando si utilizzano tubazioni esistenti, seguire il manuale di installazione in dotazione con l'unità esterna.

(\*1) Consultare la "Definizione di installatore qualificato o tecnico dell'assistenza qualificato".

Gracias por haber adquirido este aparato de aire acondicionado Toshiba.

Lea atentamente estas instrucciones que contienen información importante de conformidad con la Directiva relativa a "Máquinas" (Directiva 2006/42/EC) y asegúrese de que las entiende.

Tras completar el trabajo de instalación, entregue al usuario este Manual de instalación así como el Manual del propietario que se suministran y pídale que los guarde en un lugar seguro para poder consultarlos en el futuro.

#### Denominación genérica: Acondicionador de aire

#### Definición de instalador cualificado o persona de servicio cualificada

El aparato de aire acondicionado deberá ser instalado, mantenido, reparado y desechado por un instalador cualificado o por una persona de servicio cualificada. Cuando se tenga que hacer uno cualquiera de estos trabajos, solicite a un instalador cualificado o a una persona de servicio cualificada que le haga el trabajo solicitado. Un instalador cualificado o una persona de servicio cualificada es un agente con las cualificaciones y conocimientos descritos en la tabla de abajo.

Agente	Cualificaciones y conocimientos que debe tener el agente
Instalador cualificado	<ul style="list-style-type: none"> <li>El instalador cualificado es una persona que se dedica a la instalación, mantenimiento, traslado y retirada de los aparatos de aire acondicionado fabricados por Toshiba Carrier Corporation. Dicha persona habrá recibido formación relativa a la instalación, mantenimiento, traslado y retirada de aparatos de aire acondicionado fabricados por Toshiba Carrier Corporation, o, de otro modo, habrá sido instruido en dichas operaciones por otra u otras personas que hayan recibido formación en la materia y que por tanto posean amplios conocimientos relativos a dichas operaciones.</li> <li>El instalador cualificado que esté autorizado para realizar los trabajos eléctricos propios de la instalación, traslado y retirada poseerá las cualificaciones relativas a dichos trabajos eléctricos, de conformidad con la legislación local vigente, y habrá recibido formación relativa a las tareas eléctricas a realizar en los aparatos de aire acondicionado fabricados por Toshiba Carrier Corporation, o, de otro modo, habrá sido instruido en dichas tareas por otra u otras personas que hayan recibido formación en la materia y que por tanto posean amplios conocimientos relativos a dichas operaciones.</li> <li>El instalador cualificado que esté autorizado para realizar los trabajos de canalización y manejo del refrigerante propios de la instalación, traslado y retirada poseerá las cualificaciones relativas a dichos trabajos de canalización y manejo del refrigerante, de conformidad con la legislación local vigente, y habrá recibido formación relativa a las tareas de canalización y uso del refrigerante a realizar en los aparatos de aire acondicionado fabricados por Toshiba Carrier Corporation, o, de otro modo, habrá sido instruido en dichas tareas por otra u otras personas que hayan recibido formación en la materia y que por tanto posean amplios conocimientos relativos a dichas operaciones.</li> <li>El instalador cualificado que esté autorizado para trabajar en alturas habrá recibido formación relativa a la realización de trabajos en altura con los aparatos de aire acondicionado fabricados por Toshiba Carrier Corporation, o, de otro modo, habrá sido instruido en dichas tareas por otra u otras personas que hayan recibido formación en la materia y que por tanto posean amplios conocimientos relativos a dichos trabajos.</li> </ul>
Persona de servicio cualificada	<ul style="list-style-type: none"> <li>La persona de servicio cualificada es una persona que se dedica a la instalación, reparación, mantenimiento, traslado y retirada de los aparatos de aire acondicionado fabricados por Toshiba Carrier Corporation. Dicha persona habrá recibido formación relativa a la instalación, reparación, mantenimiento, traslado y retirada de aparatos de aire acondicionado fabricados por Toshiba Carrier Corporation, o, de otro modo, habrá sido instruido en dichas operaciones por otra u otras personas que hayan recibido formación en la materia y que por tanto posean amplios conocimientos relativos a dichas operaciones.</li> <li>La persona de servicio cualificada que esté autorizada para realizar los trabajos eléctricos propios de la instalación, reparación, traslado y retirada poseerá las cualificaciones relativas a dichos trabajos eléctricos, de conformidad con la legislación local vigente, y habrá recibido formación relativa a las tareas eléctricas a realizar en los aparatos de aire acondicionado fabricados por Toshiba Carrier Corporation, o, de otro modo, habrá sido instruido en dichas tareas por otra u otras personas que hayan recibido formación en la materia y que por tanto posean amplios conocimientos relativos a dichas operaciones.</li> <li>La persona de servicio cualificada que esté autorizada para realizar los trabajos de canalización y manejo del refrigerante propios de la instalación, reparación, traslado y retirada poseerá las cualificaciones relativas a dichos trabajos de canalización y manejo del refrigerante, de conformidad con la legislación local vigente, y habrá recibido formación relativa a las tareas de canalización y uso del refrigerante a realizar en los aparatos de aire acondicionado fabricados por Toshiba Carrier Corporation, o, de otro modo, habrá sido instruido en dichas tareas por otra u otras personas que hayan recibido formación en la materia y que por tanto posean amplios conocimientos relativos a dichas operaciones.</li> <li>La persona de servicio cualificada que esté autorizada para trabajar en alturas habrá recibido formación relativa a la realización de trabajos en altura con los aparatos de aire acondicionado fabricados por Toshiba Carrier Corporation, o, de otro modo, habrá sido instruido en dichas tareas por otra u otras personas que hayan recibido formación en la materia y que por tanto posean amplios conocimientos relativos a dichos trabajos.</li> </ul>

#### Definición del equipo de protección



Cuando vaya a proceder al traslado, instalación, mantenimiento, reparación o retirada del aparato de aire acondicionado, utilice guantes protectores y ropa de trabajo de "seguridad".

Además de este equipo protector habitual, utilice el equipo protector que se describe a continuación cuando emprenda las operaciones especiales que se detallan en la tabla siguiente.

De no utilizar el equipo protector adecuado, incurrirá en cierto riesgo personal ya que estará más expuesto a sufrir heridas, quemaduras, descargas eléctricas y demás lesiones.





Trabajo realizado	Equipo de protección usado
Todo tipo de trabajos	Guantes de protección Ropa de trabajo de "seguridad"
Trabajo relacionado con equipos eléctricos	Guantes para protegerse de las descargas eléctricas Calzado aislante Ropa que ofrezca protección contra descargas eléctricas
Trabajos en altura (50 cm o más)	Cascos de seguridad de uso industrial
Transporte de objetos pesados	Zapatos con protección adicional en las punteras
Reparación de la unidad exterior	Guantes para protegerse de las descargas eléctricas

Estas precauciones de seguridad describen aspectos importantes relacionados con la seguridad para evitar lesiones a los usuarios o a terceros y daños materiales. Por favor lea este manual después de comprender el siguiente contenido (significado de las indicaciones) y asegúrese de observar las descripciones.





Indicación	Significado de las indicaciones
 <b>ADVERTENCIA</b>	El texto que se resalta de esta forma indica que el no cumplimiento de las instrucciones en la advertencia podría provocar lesiones personales muy graves (*1) o la muerte si el producto se manipula indebidamente.
 <b>PRECAUCIÓN</b>	El texto que se resalta de esta forma indica que el no cumplimiento de las instrucciones en la precaución podría provocar lesiones leves (*2) o daños (*3) a la propiedad si el producto se manipula indebidamente.

\*1: Las lesiones personales muy incluyen: pérdida de la vista, heridas, quemaduras, electrocución, fracturas, envenenamiento y otras lesiones que dejan secuelas y requieren hospitalización o tratamientos ambulatorios prolongados.  
\*2: Las lesiones leves incluyen: heridas, quemaduras, electrocución u otras lesiones que no requieren hospitalización ni tratamiento ambulatorio prolongado.  
\*3: Daño a la propiedad indica daños a edificios, elementos del hogar, ganado doméstico o mascotas.

#### SIGNIFICADO DE LOS SÍMBOLOS VISUALIZADOS EN LA UNIDAD

	<b>ADVERTENCIAS</b> (Riesgo de incendio)	Esta marca es únicamente para el refrigerante R32. El tipo de refrigerante está indicado en la placa de identificación de la unidad exterior. Si el tipo de refrigerante es R32, esta unidad utiliza un refrigerante inflamable. En caso de fugas de refrigerante y si entra en contacto con llamas o piezas calientes, emitirá gases nocivos y existe el riesgo de que se produzcan incendios.
	Lea atentamente el MANUAL DEL PROPIETARIO antes de la operación.	
	El personal de servicio debe leer detenidamente el MANUAL DEL PROPIETARIO y el MANUAL DE INSTALACIÓN antes de la operación.	
	Podrá encontrar más información en el MANUAL DEL PROPIETARIO, MANUAL DE INSTALACIÓN, etc.	

■ **Advertencias en cuanto a la unidad de aire acondicionado**

Indicación de advertencia		Descripción
	<p><b>WARNING</b></p> <p><b>ELECTRICAL SHOCK HAZARD</b> Disconnect all remote electric power supplies before servicing.</p>	<p><b>ADVERTENCIA</b></p> <p><b>PELIGRO DE DESCARGA ELÉCTRICA</b> Desconecte todos los suministros eléctricos remotos antes de hacer reparaciones.</p>
	<p><b>WARNING</b></p> <p>Moving parts. Do not operate unit with grille removed. Stop the unit before the servicing.</p>	<p><b>ADVERTENCIA</b></p> <p>Piezas móviles. No utilice la unidad con la rejilla retirada. Pare la unidad antes de hacer reparaciones.</p>
	<p><b>CAUTION</b></p> <p>High temperature parts. You might get burned when removing this panel.</p>	<p><b>PRECAUCIÓN</b></p> <p>Piezas de alta temperatura. Al retirar este panel podría quemarse.</p>
	<p><b>CAUTION</b></p> <p>Do not touch the aluminum fins of the unit. Doing so may result in injury.</p>	<p><b>PRECAUCIÓN</b></p> <p>No toque las aletas de aluminio del aparato. De lo contrario, podrían producirse lesiones personales.</p>
	<p><b>CAUTION</b></p> <p><b>BURST HAZARD</b> Open the service valves before the operation, otherwise there might be the burst.</p>	<p><b>PRECAUCIÓN</b></p> <p><b>PELIGRO DE ROTURA</b> Abra las válvulas de servicio antes de la operación, de lo contrario podrían producirse roturas.</p>

# 1 Precauciones de seguridad

El fabricante no asumirá ninguna responsabilidad por los daños causados por no seguir las descripciones de este manual.

## **ADVERTENCIA**

### General

- Antes de empezar a instalar el acondicionador de aire, lea atentamente el manual de instalación y siga sus instrucciones para instalarlo.
- Solo un instalador cualificado o una persona de mantenimiento cualificada tiene permiso para realizar los trabajos de instalación. La instalación incorrecta puede provocar fugas de agua, descargas eléctricas o incendios.
- No utilice ningún refrigerante distinto del especificado como complemento o sustituto. Si lo hace, se podría generar una presión extremadamente alta en el ciclo de refrigeración, lo que podría causar un fallo en el producto, la explosión de este o daños físicos.
- Antes de abrir la rejilla de toma de aire de la unidad interior o el panel de servicio de la unidad exterior, ponga el disyuntor en la posición OFF. Si no se coloca el disyuntor en la posición OFF, se puede producir una descarga eléctrica por contacto con las piezas interiores. Sólo un instalador cualificado (\*1) o una persona de servicio cualificada (\*1) tiene permitido retirar la rejilla de admisión de la unidad interior o el panel de servicio de la unidad exterior y hacer el trabajo necesario.
- Antes de realizar la instalación, el mantenimiento, la reparación o la desinstalación, coloque el disyuntor en la posición de apagado (OFF). De lo contrario se pueden producir descargas eléctricas.
- Ponga un aviso que diga "trabajo en curso" cerca del disyuntor mientras se realiza el trabajo de instalación, mantenimiento, reparación o desecho. Si el disyuntor se pone en ON por error existe el peligro de que se produzcan descargas eléctricas.
- Sólo un instalador cualificado (\*1) o una persona de servicio cualificada (\*1) tiene permiso para realizar trabajos en lugares altos usando una base de 50 cm o más o para quitar la rejilla de admisión de la unidad interior para realizar otros trabajos.
- Utilice guantes de protección y ropa de trabajo segura durante la instalación, reparación y retirada.
- No toque la aleta de aluminio de la unidad. Si lo hace, podría lesionarse. Si por algún motivo tuviera que tocar la aleta, póngase primero guantes de protección y ropa de trabajo segura, y luego empiece a trabajar.
- No se suba encima de la unidad exterior ni coloque objetos sobre ella. Usted o los objetos pueden caerse de la unidad exterior y provocar lesiones.



- Cuando trabaje en alturas, utilice una escalera que cumpla la norma ISO 14122 y siga los procedimientos indicados en las instrucciones de la escalera. Póngase también un casco de uso industrial como equipo de protección para hacer el trabajo.
- Antes de limpiar el filtro u otras partes de la unidad exterior, ponga sin falta el disyuntor en la posición OFF, y ponga un aviso que diga “trabajo en curso” cerca del disyuntor mientras se realiza el trabajo.
- Cuando vaya a trabajar en alturas, coloque un cartel en el lugar adecuado antes de comenzar para que nadie se aproxime a la zona de trabajo. Desde la parte superior podrían caer piezas y otros objetos que causarían lesiones a las personas situadas debajo. Cuando esté realizando un trabajo, utilice casco para protegerse de los objetos que pudieran caer.
- No use refrigerante que no sea R32 o R410A. Para obtener información sobre el tipo de refrigerante, compruebe la unidad exterior a combinar.
- El acondicionador de aire debe transportarse en condiciones estables. Si alguna pieza del producto está rota, póngase en contacto con el proveedor.
- Cuando la unidad de aire acondicionado se deba transportar con las manos, deberán hacerlo dos o más personas.
- No mueva ni repare ninguna unidad usted mismo. La unidad contiene alto voltaje en su interior. Podría recibir una descarga eléctrica al retirar la cubierta y la unidad principal.
- El uso de este aparato está destinado a personal especializado o a usuarios con formación para tiendas e industria ligera, o a un uso comercial para el público en general.

### Selección del lugar de instalación

- Cuando la unidad de aire acondicionado se instale en una habitación pequeña, asegúrese de que las medidas son adecuadas para garantizar que la concentración de refrigerante que se produce por la fuga de este en la habitación no sobrepase el nivel crítico.
- No instale el producto en lugares donde puedan existir fugas de gases inflamables. Si se produjera una fuga de gas y este se acumulara alrededor de la unidad, podría prender y provocarse un incendio.
- Utilice calzado con protección adicional para el extremo del pie cuando transporte la unidad de aire acondicionado.
- Para transportar el acondicionador de aire, no lo agarre por las bandas de alrededor del cartón de embalaje. Podría lesionarse en caso de rotura de las bandas.
- Instale la unidad interior a 2,5 m como mínimo por encima del nivel del suelo, ya que de lo contrario los usuarios podrían lesionarse o recibir descargas eléctricas si meten sus dedos u otros objetos en la unidad interior mientras funciona el aparato de aire acondicionado.
- No ponga ningún aparato de combustión en un lugar expuesto directamente al aire procedente del acondicionador de aire, de lo contrario, la combustión no sería perfecta.

- El aparato y las tuberías deben ser instalados, operados y almacenados en una habitación con más de  $A_{\min}$  m<sup>2</sup> de suelo.  
Cómo lograr  $A_{\min}$  m<sup>2</sup>:  $A_{\min} = (M / (2,5 \times 0,22759 \times h_0))^2$   
M es la cantidad de carga de refrigerante en el aparato en kg;  
 $h_0$  es la altura de instalación del aparato en m:  
0,6 m para la instalación en suelo/1,8 m para la instalación en pared/1,0 m para la instalación en ventana/2,2 m para la instalación en techo.  
(Solo modelos de refrigerante R32. Para obtener más información, consulte el Manual de instalación de la unidad exterior).

### Instalación

- Cuando la unidad interior vaya a instalarse suspendida deberán usarse los pernos para colgar (M10 ó W3/8) y las tuercas (M10 ó W3/8) que han sido designados.
- Instale la unidad de aire acondicionado asegurándose de que queda bien sujeta en una ubicación cuya base pueda soportar el peso adecuadamente. Si la resistencia no es suficiente, la unidad puede caerse y causar lesiones.
- Siga las instrucciones del manual de instalación para instalar el aparato de aire acondicionado. De no seguir esta instrucción, el producto podría caer o volcarse, así como generar más ruido, vibraciones, fugas de agua y otros problemas.
- Lleve a cabo el procedimiento de instalación especificado para proteger la unidad contra posibles vientos fuertes y terremotos. Si no se instala la unidad de aire acondicionado correctamente, podría caer o volcarse y causar un accidente.
- Si se producen fugas de gas refrigerante durante la instalación, ventile inmediatamente la habitación. Si la fuga de refrigerante entra en contacto con fuego, se podrían generar gases tóxicos.
- Utilice una carretilla elevadora para transportar las unidades de aire acondicionado y cabestrantes o montacargas para la instalación.

### Tubería del refrigerante

- Instale firmemente el tubo del refrigerante durante los trabajos de instalación antes de poner en funcionamiento el aparato de aire acondicionado. Si el compresor funciona con su válvula abierta y sin tubo de refrigerante, el compresor succionará aire y los ciclos de refrigeración tendrán una presión excesiva, lo que puede causar lesiones.
- Apriete la tuerca abocinada con una llave de ajuste dinamométrica como se indica. Un apriete excesivo de la tuerca abocinada puede causar grietas en la misma con el paso del tiempo, lo que podría causar fugas de refrigerante.
- Tras la instalación, asegúrese de que no existen fugas de gas refrigerante. Si se produce una fuga de gas refrigerante en la habitación y hay una fuente de fuego próxima, como una cocina, podría generarse gas nocivo.

- Cuando el acondicionador de aire haya sido instalado o trasladado, siga las instrucciones del manual de instalación y purgue completamente el aire para que no se mezclen otros gases que no sean el refrigerante en el ciclo de refrigeración. Si el aire no se purga completamente puede que el acondicionador de aire funcione de forma incorrecta.
- Para la prueba de hermeticidad al aire deberá usarse gas nitrógeno.
- La manguera de carga deberá conectarse de forma que no esté floja.

### **Cableado eléctrico**

- Sólo un instalador cualificado (\*1) o una persona de servicio cualificada (\*1) tiene permitido realizar el trabajo eléctrico del aparato de aire acondicionado. Este trabajo no deberá hacerlo, bajo ninguna circunstancia, una persona que no esté cualificada, ya que si el trabajo se efectúa de forma incorrecta, existe el peligro de que se produzcan descargas eléctricas y/o fugas eléctricas.
- Para conectar los cables eléctricos, reparar los componentes eléctricos o realizar otros trabajos con equipos eléctricos, póngase guantes y ropa para protegerse de las descargas eléctricas, así como zapatos aislantes. Si no se pone este equipo de protección puede recibir descargas eléctricas.
- Use cables que cumplan con las especificaciones del manual de instalación y las estipulaciones de las normas y leyes locales. El uso de cables que no cumplen con las especificaciones puede dar origen a descargas eléctricas, fugas eléctricas, humo y/o incendios.
- Conecte la toma de tierra. (Masa)  
Una conexión a tierra incompleta provocará descargas eléctricas.
- No conecte la toma de tierra a tuberías de gas o agua, a un pararrayos ni a una toma de tierra de teléfono.
- Cuando haya finalizado el trabajo de reparación o reubicación, compruebe que la toma de tierra esté conectada adecuadamente.
- Instale un disyuntor que cumpla con las especificaciones del manual de instalación y con las estipulaciones de las normas y las leyes locales.
- Instale el disyuntor donde el agente pueda tener acceso a él fácilmente.
- Cuando instale el disyuntor en el exterior, instale uno diseñado para ser usado en exteriores.
- Bajo ninguna circunstancia se deben conectar el cable del suministro de alimentación o el cable de conexión interior y exterior por el medio (conexión mediante un terminal sin soldadura, etc.)  
Los problemas de conexión en lugares donde el cable se conecta por el medio podrían generar humo y/o un incendio.
- El cableado eléctrico deberá realizarse de conformidad con la legislación local vigente y el Manual de instalación.  
No se ser así, podría producirse una electrocución o un cortocircuito.

### **Prueba de funcionamiento**

- Antes de utilizar el acondicionador de aire después de completar el trabajo de instalación, compruebe que la cubierta de la caja de componentes eléctricos de la unidad interior y del panel de servicio de la unidad exterior esté cerrada, y ponga el disyuntor en la posición ON. Si conecta la alimentación sin realizar primero estas comprobaciones, puede recibir una descarga eléctrica.
- Si surge cualquier problema (por ejemplo, si aparece un código de comprobación en la pantalla, huele a quemado, se producen sonidos anormales, la unidad no enfría o no calienta o se produce una fuga de agua) con la unidad de aire acondicionado, no la toque usted mismo; coloque el disyuntor en la posición de apagado (OFF) y póngase en contacto con personal de servicio cualificado. Tome medidas (colocando un aviso de "Fuera de servicio" cerca del disyuntor, por ejemplo) para asegurar que la alimentación no se conecte antes de que llegue la persona de mantenimiento cualificada. Si se continúa utilizando la unidad de aire acondicionado con la anomalía, los problemas mecánicos podrían generar otras complicaciones o provocar descargas eléctricas u otro tipo de problemas.
- Después de terminar el trabajo, utilice el verificador de aislamiento (megóhmetro de 500 V) para verificar que la resistencia sea de 1 MΩ o más entre la sección de carga y la sección de metal de no carga (sección de tierra). Si el valor de la resistencia es bajo, esto se debe a un fallo como, por ejemplo, una fuga o una descarga eléctrica en el lado del usuario.
- Al completar el trabajo de instalación, compruebe que no haya fugas de refrigerante, y también la resistencia del aislamiento y el drenaje de agua. A continuación, efectúe una prueba de funcionamiento para comprobar si el acondicionador de aire funciona correctamente.

### **Explicaciones para dar al usuario**

- Al finalizar el trabajo de instalación, indique al usuario dónde se encuentra el disyuntor. Si el usuario no sabe dónde está el disyuntor, él o ella no podrán desconectar la alimentación en el caso de que se produzca un fallo en el acondicionador de aire.
- Tras finalizar la instalación, consulte el manual del propietario para explicarle al cliente cómo utilizar y cuidar la unidad.

---

## Traslado

- Sólo un instalador cualificado (\*1) o una persona de servicio cualificada (\*1) tiene permiso para recolocar el aparato de aire acondicionado. Es peligroso para el aparato de aire acondicionado que sea recolocado por un individuo no cualificado, porque se puede producir un incendio, descargas eléctricas, lesiones, fugas de agua, ruido y/o vibración.
  - Cuando realice trabajos de bombeo de vacío, cierre el compresor antes de desconectar el tubo del refrigerante. Si se desconecta el tubo de refrigerante con la válvula de mantenimiento abierta y el compresor aún en marcha, se aspirará aire u otro gas, elevando la presión dentro del ciclo de refrigeración a niveles excesivamente altos, lo que podrá provocar roturas, lesiones u otros problemas.
- 

---

## PRECAUCIÓN

**Este aparato de aire acondicionado incorpora el refrigerante HFC (R32 o R410A) respetuoso con la capa de ozono.**

- Puesto que el refrigerante R32 o R410A se ve afectado fácilmente por impurezas tales como la humedad, películas de óxido, aceite, etc., debido a la alta presión, tenga cuidado para no permitir que la humedad, la suciedad, el refrigerante existente, el aceite de la máquina de refrigeración, etc., se mezclen en el ciclo de refrigeración durante las tareas de instalación.
  - Para la instalación, es necesaria una herramienta especial para el refrigerante R32 o R410A.
  - Use materiales de tubería nuevos y limpios para la tubería de conexión de modo que la humedad y la suciedad no se mezclen durante las tareas de instalación.
  - Al usar las tuberías existentes, siga el manual de instalación adjunto con la unidad exterior.
- 

(\*1) Consulte la "Definición de instalador cualificado o persona de servicio cualificada".

Obrigado por ter adquirido este ar condicionado da Toshiba.

Leia estas instruções com cuidado, pois contém informações importantes que cumpre a Directiva "Máquinas" (Directiva 2006/42/CE), e assegure-se de que as entende.

Depois de concluir o trabalho de instalação, entregue este Manual de Instalação e o Manual do Proprietário que acompanha a unidade exterior ao utilizador, e peça ao utilizador para guardá-los num lugar seguro para futuras consultas.

**Denominação genérica: Ar condicionado**

**Definição de instalador qualificado ou de técnico de assistência qualificado**

O ar condicionado deve ser instalado, mantido, reparado e eliminado por um instalador qualificado ou um técnico de assistência qualificado. Quando for necessário efectuar qualquer um destes trabalhos, peça a um instalador qualificado ou a um técnico de assistência qualificado para efectuar estes trabalhos.

Um instalador qualificado ou um técnico de assistência qualificado é um agente com as qualificações e os conhecimentos descritos na tabela abaixo.

Agente	Qualificações e conhecimentos necessários do agente
Instalador qualificado	<ul style="list-style-type: none"> <li>O instalador qualificado é uma pessoa que instala, dá manutenção a, muda de lugar e remove os ares condicionados fabricados pela Toshiba Carrier Corporation. Esta pessoa deve ter formação para instalar, dar manutenção a, mudar de lugar e remover sistemas de ar condicionado fabricados pela Toshiba Carrier Corporation ou, como alternativa, deve ter sido instruída nessas operações por parte de indivíduos com a formação devida e, portanto, que adquiriram todo o conhecimento relacionado com estas operações.</li> <li>O instalador qualificado que tem permissão para levar a cabo as ligações eléctricas envolvidas na instalação, deslocação e remoção tem as qualificações necessárias para realizar essas tarefas conforme estipulado pelas leis e regulamentos locais, sendo uma pessoa que fez formação nas matérias relacionadas com trabalho eléctrico nos sistemas de ar condicionado fabricados pela Toshiba Carrier Corporation ou, como alternativa, que foi instruída nessas matérias por parte de indivíduos com a formação devida e, portanto, que adquiriram todo o conhecimento relacionado com este trabalho.</li> <li>O instalador qualificado que tem permissão para realizar as tarefas de manuseamento do refrigerante e de instalação das tubagens envolvidas na instalação, deslocação e remoção dos aparelhos tem as qualificações necessárias para o manuseamento do refrigerante e a instalação das tubagens conforme estipulado pelas leis e regulamentos locais, sendo uma pessoa que fez formação nas matérias relacionadas com o manuseamento de refrigerante e a instalação de tubagens nos sistemas de ar condicionado fabricados pela Toshiba Carrier Corporation ou, como alternativa, que foi instruída nessas matérias por parte de indivíduos com a formação devida e, portanto, que adquiriram todo o conhecimento relacionado com estas tarefas.</li> <li>O instalador qualificado, a quem é permitido trabalhar em altura, foi formado em matérias relacionadas com o trabalho em altura com sistemas de ar condicionado fabricados pela Toshiba Carrier Corporation ou, como alternativa, foi instruído nessas matérias por indivíduos com a formação devida e, portanto, que adquiriram todo o conhecimento relacionado com este trabalho.</li> </ul>
Técnico de assistência qualificado	<ul style="list-style-type: none"> <li>O técnico de assistência qualificado é uma pessoa que instala, repara, dá manutenção a, muda de lugar e remove os sistemas de ar condicionado fabricados pela Toshiba Carrier Corporation. Esta pessoa deve ter formação para instalar, reparar, dar manutenção a, mudar de lugar e remover sistemas de ar condicionado fabricados pela Toshiba Carrier Corporation ou, como alternativa, deve ter sido instruída nessas operações por parte de indivíduos com a formação devida e, portanto, que adquiriram todo o conhecimento relacionado com estas operações.</li> <li>O técnico de assistência qualificado que tem permissão para levar a cabo as ligações eléctricas envolvidas na instalação, deslocação e remoção tem as qualificações necessárias para realizar essas tarefas conforme estipulado pelas leis e regulamentos locais, sendo uma pessoa que fez formação nas matérias relacionadas com trabalho eléctrico nos sistemas de ar condicionado fabricados pela Toshiba Carrier Corporation ou, como alternativa, que foi instruída nessas matérias por parte de indivíduos com a formação devida e, portanto, que adquiriram todo o conhecimento relacionado com este trabalho.</li> <li>O técnico de assistência qualificado que tem permissão para realizar as tarefas de manuseamento do refrigerante e de instalação das tubagens envolvidas na instalação, reparação, deslocação e remoção dos aparelhos tem as qualificações necessárias para o manuseamento do refrigerante e a instalação das tubagens conforme estipulado pelas leis e regulamentos locais, sendo uma pessoa que fez formação nas matérias relacionadas com o manuseamento de refrigerante e a instalação de tubagens nos sistemas de ar condicionado fabricados pela Toshiba Carrier Corporation ou, como alternativa, que foi instruída nessas matérias por parte de indivíduos com a formação devida e, portanto, que adquiriram todo o conhecimento relacionado com estas tarefas.</li> <li>O técnico de assistência qualificado, a quem é permitido trabalhar em altura, foi formado em matérias relacionadas com o trabalho em altura com sistemas de ar condicionado fabricados pela Toshiba Carrier Corporation ou, como alternativa, foi instruído nessas matérias por indivíduos com a formação devida e, portanto, que adquiriram todo o conhecimento relacionado com este trabalho.</li> </ul>

**Definição do equipamento de protecção**



Aquando do transporte, instalação, manutenção, reparação ou remoção do ar condicionado, use luvas e vestuário de protecção.

Além do equipamento de protecção normal, use o equipamento de protecção descrito abaixo, se levar a cabo os trabalhos especiais detalhados na tabela abaixo.

É perigoso não usar o equipamento de protecção adequado porque fica mais suscetível a sofrer lesões, queimaduras, choques eléctricos e outros ferimentos.





Trabalho efectuado	Equipamento de protecção usado
Todos os tipos de trabalhos	Luvas de protecção Vestuário de protecção
Trabalho eléctrico	Luvas para proteger electricistas Sapatos isoladores Vestuário que proteja contra choques eléctricos
Trabalhos em altura (50 cm ou mais)	Capacetes industriais
Transporte de objectos pesados	Sapatos com protecção adicional para os dedos dos pés
Reparação da unidade exterior	Luvas para proteger electricistas

Estas precauções de segurança descrevem assuntos importantes sobre a segurança para prevenir ferimentos aos utilizadores ou outras pessoas, e danos à propriedade. Leia atentamente este manual depois de compreender bem o conteúdo abaixo (significados das indicações), e certifique-se de seguir as instruções.





Indicação	Significado das indicações
 <b>AVISO</b>	O texto que aparece nestas indicações indica que a não observação das instruções na advertência poderia provocar sérias lesões físicas (*1) ou a morte se o produto for manipulado inadequadamente.
 <b>ATENÇÃO</b>	O texto que aparece nestas indicações indica que a não observação das instruções na advertência poderia provocar lesões ligeiras (*2) ou danos (*3) à propriedade se o produto for manipulado inadequadamente.

\*1: Sérias lesões físicas indicam a perda da visão, ferimentos corporais, queimaduras, choque eléctrico, fratura, intoxicação e outras lesões que deixam efeitos secundários e requerem a hospitalização ou tratamento ambulatorio prolongado.  
\*2: Lesões ligeiras indicam ferimentos corporais, queimaduras, choque eléctrico e outras lesões que não requerem hospitalização ou tratamento ambulatorio prolongado.  
\*3: Danos à propriedade indicam danos causados a prédios, objetos de uso doméstico e bens móveis, gado e animais domésticos.

**SIGNIFICADOS DE SÍMBOLOS APRESENTADOS NA UNIDADE**

	<b>AVISO</b> (Risco de incêndio)	Esta marca é apenas para o refrigerante R32. O tipo de refrigerante está escrito na placa de identificação da unidade exterior. Caso esse tipo de refrigerante seja R32, esta unidade usa um refrigerante inflamável. Se houver uma fuga de refrigerante e este entrar em contato com o fogo ou uma peça aquecida, criará gases tóxicos e existe risco de incêndio.
		Leia cuidadosamente o MANUAL DO PROPRIETÁRIO antes do funcionamento.
		Os técnicos de assistência devem ler cuidadosamente o MANUAL DO PROPRIETÁRIO e o MANUAL DE INSTALAÇÃO antes da operação.
		Está disponível mais informação no MANUAL DO PROPRIETÁRIO, MANUAL DE INSTALAÇÃO e semelhantes.

## ■ Indicações de aviso sobre o ar condicionado

Indicação de aviso		Descrição
	<b>WARNING</b> <b>ELECTRICAL SHOCK HAZARD</b> Disconnect all remote electric power supplies before servicing.	<b>AVISO</b> <b>PERIGO DE CHOQUE ELÉCTRICO</b> Desligue todas as fontes de alimentação eléctrica remotas antes de uma operação de assistência.
	<b>WARNING</b> Moving parts. Do not operate unit with grille removed. Stop the unit before the servicing.	<b>AVISO</b> Peças rotativas. Não utilize a unidade com a grelha retirada. Pare a unidade antes de uma operação de assistência.
	<b>CAUTION</b> High temperature parts. You might get burned when removing this panel.	<b>ATENÇÃO</b> Peças com elevadas temperaturas. Pode queimar-se quando retirar este painel.
	<b>CAUTION</b> Do not touch the aluminum fins of the unit. Doing so may result in injury.	<b>ATENÇÃO</b> Não toque nas barbatanas de alumínio da unidade. Caso contrário, poderá ferir-se.
	<b>CAUTION</b> <b>BURST HAZARD</b> Open the service valves before the operation, otherwise there might be the burst.	<b>ATENÇÃO</b> <b>PERIGO DE EXPLOSÃO</b> Abra as válvulas de serviço antes de utilizar o equipamento, caso contrário, pode ocorrer uma explosão.

# 1 Precauções de segurança

O fabricante não assumirá nenhuma responsabilidade por danos causados pela não observação das descrições dadas neste manual.

## AVISO

### Geral

- Antes de instalar o ar condicionado, leia cuidadosamente o Manual de Instalação e siga as instruções fornecidas para instalar o ar condicionado.
- Apenas um instalador qualificado ou um técnico de assistência qualificado pode efectuar o trabalho de instalação. A instalação incorrecta pode provocar fugas de água, choques eléctricos ou incêndio.
- Não utilize um refrigerante diferente do especificado para complementação ou substituição. Caso contrário, uma pressão anormalmente alta pode ser gerada no ciclo de refrigeração, o que pode resultar numa falha ou explosão do produto ou em ferimentos pessoais.
- Antes de abrir a grelha de entrada da unidade interior ou painel de serviço da unidade exterior, coloque o disjuntor eléctrico na posição OFF. A não colocação do disjuntor eléctrico na posição OFF pode provocar choques eléctricos devido ao contacto com as peças internas. Apenas um instalador qualificado (\*1) ou um técnico de assistência qualificado (\*1) pode retirar a grelha de entrada da unidade interior ou o painel de serviço da unidade exterior e efectuar os trabalhos necessários.
- Antes de efectuar o trabalho de instalação, manutenção, reparação ou de eliminação, coloque o disjuntor eléctrico na posição OFF. Caso contrário, podem ocorrer choques eléctricos.
- Coloque um sinal "Trabalho em progresso" junto ao disjuntor eléctrico durante a realização de trabalhos de instalação, manutenção, reparação ou eliminação. Existe um perigo de choques eléctricos se colocar o disjuntor eléctrico na posição ON por engano.
- Apenas um instalador qualificado (\*1) ou um técnico de assistência qualificado (\*1) pode efectuar o trabalho em altura com um suporte de 50 cm ou mais, ou retirar a grelha de entrada da unidade interior para efectuar o trabalho.
- Use luvas de protecção e vestuário de trabalho de segurança durante a instalação, a assistência e a eliminação.
- Não toque na barbatana de alumínio da unidade. Pode ferir-se, se o fizer. Se for necessário tocar na palheta por algum motivo, coloque primeiro as luvas de protecção e o vestuário de trabalho de segurança e, em seguida, prossiga.
- Não suba para nem coloque objectos sobre a unidade exterior. Pode cair ou os objectos podem cair da unidade exterior e provocar ferimentos.

- Quando trabalhar em altura, utilize uma escada em conformidade com a norma ISO 14122 e efectue o procedimento descrito nas instruções da escada. Use também um capacete industrial como equipamento de protecção para efectuar o trabalho.
- Antes de limpar o filtro ou outras peças da unidade exterior, não se esqueça de colocar o disjuntor eléctrico na posição OFF e um sinal “Trabalho em progresso” junto ao disjuntor eléctrico antes de continuar o trabalho.
- Antes de trabalhar em altura, coloque um sinal no local para que ninguém se aproxime do local de trabalho antes de continuar com o trabalho. As peças e outros objectos podem cair da parte superior, ferindo possivelmente uma pessoa que esteja por baixo. Enquanto realiza o trabalho, utilize um capacete para protecção contra a queda de objectos.
- Não use outro refrigerante que não o R32 ou R410A. Sobre o tipo de refrigerante, verifique a unidade exterior a ser combinada.
- O aparelho de ar condicionado deve ser transportado numa condição estável. Se encontrar qualquer parte do produto quebrada, contacte o seu revendedor.
- Se o aparelho de ar condicionado tiver que ser transportado manualmente, duas ou mais pessoas devem carregá-lo.
- Não mova ou repare qualquer unidade. Há tensão alta no interior da unidade. Pode sofrer um choque eléctrico quando retirar a tampa e a unidade principal.
- Este aparelho destina-se à utilização por parte de especialistas ou utilizadores com formação em oficinas, em indústria ligeira ou para uso comercial por leigos.

### Seleção do local de instalação

- Quando o aparelho de ar condicionado for instalado em um ambiente pequeno, providencie medidas apropriadas para assegurar que a concentração de fuga do refrigerante que possa ocorrer no ambiente não exceda o nível crítico.
- Não instale num local onde gases inflamáveis possam vazar. Se algum gás vazar e acumular-se ao redor da unidade, o mesmo pode inflamar e causar um incêndio.
- Para transportar o ar condicionado, use sapatos com protecções adicionais para os dedos dos pés.
- Para transportar o ar condicionado, não segure nas faixas existentes à volta da embalagem de cartão. Pode ferir-se, se as faixas se partirem.
- Instale a unidade interior a pelo menos 2,5 m acima do nível do chão, caso contrário, os utilizadores podem ferir-se ou sofrerem choques eléctricos se tocarem com os dedos ou outros objectos na unidade interior com o ar condicionado em funcionamento.
- Não coloque nenhum aparelho de combustão num local exposto directamente ao vento do ar condicionado, caso contrário, pode provocar uma combustão imperfeita.

- O aparelho e as tubulações devem ser instalados, operados e armazenados em uma sala com uma área de piso superior a  $A_{\min} \text{ m}^2$ . Como obter  $A_{\min} \text{ m}^2$ :  $A_{\min} = (M / (2,5 \times 0,22759 \times h_0))^2$   
M é a quantidade de carga de refrigerante no aparelho em **kg**;  
 $h_0$  é a altura de instalação do aparelho em **m**:  
0,6 m para colocação no piso / 1,8 m para montagem na parede / 1,0 m para montagem na janela / 2,2 m para montagem no teto.  
(Apenas modelos de refrigerante R32. Para obter detalhes, consulte o Manual de instalação da unidade exterior.)

### Instalação

- Quando suspender a unidade interior, tem de utilizar as porcas (M10 ou W3/8) e os parafusos de fixação (M10 ou W3/8).
- Instale o aparelho de ar condicionado firmemente num lugar onde a base possa suportar o peso adequadamente. Se a força não for suficiente, a unidade pode cair e provocar lesões.
- Siga as instruções fornecidas no Manual de Instalação para instalar o ar condicionado. O incumprimento destas instruções pode provocar a queda do produto ou produzir ruído, vibração, vazamento de água ou outros problemas.
- Realize o trabalho de instalação especificado para a protecção adequada contra a possibilidade de ventos fortes e terremotos. Se o aparelho de ar condicionado não for instalado adequadamente, uma unidade pode tombar ou cair, provocando um acidente.
- Se o gás refrigerante vazar durante o trabalho de instalação, ventile o ambiente imediatamente. Se o gás refrigerante vazado entrar em contacto com fogo, poderá ser gerado um gás nocivo.
- Utilize uma empilhadora para transportar as unidades do aparelho de ar condicionado e utilize um guincho ou guindaste para sua instalação.

### Tubagem do refrigerante

- Instale correctamente o tubo de refrigeração durante a instalação antes de colocar o ar condicionado em funcionamento. Se operar o compressor com a válvula aberta e sem o tubo de refrigerante, o compressor aspira ar e o ciclo de refrigeração é sobrepressurizado, o que poderá provocar uma lesão.
- Aperte a porca de alargamento com uma chave dinamométrica e da forma especificada. O aperto excessivo da porca de alargamento pode provocar uma racha na porca de alargamento após um longo período, que pode resultar na fuga de refrigerante.
- Após o trabalho de instalação, confirme que não haja nenhuma fuga do gás refrigerante. Se houver uma fuga de gás refrigerante para o compartimento que entre em contacto com uma chama, por exemplo, no caso de um fogão, poderá gerar gás tóxico.

- Quando instalar ou mudar o ar condicionado, siga as instruções fornecidas no Manual de Instalação e elimine o ar completamente para que nenhum gás para além do refrigerante seja misturado no ciclo de refrigeração. A não eliminação completa do ar pode provocar uma avaria no ar condicionado.
- Tem de utilizar gás de nitrogénio para o teste de impermeabilidade.
- Tem de ligar o tubo de carga para que não exista nenhuma folga.

### **Cablagem eléctrica**

- Apenas um instalador qualificado (\*1) ou um técnico de assistência qualificado (\*1) pode efectuar o trabalho eléctrico do ar condicionado. Este trabalho não deve ser efectuado por uma pessoa não qualificada em nenhuma circunstância porque um trabalho executado incorrectamente pode resultar em choques eléctricos e/ou fugas eléctricas.
- Para conectar os cabos eléctricos, reparar peças eléctricas ou efectuar outros trabalhos eléctricos, utilize luvas de protecção de electricista, sapatos isoladores e vestuário para protecção contra choques eléctricos. A não utilização deste equipamento de protecção pode resultar em choques eléctricos.
- Utilize cablagens que cumpram as especificações fornecidas no Manual de Instalação e as condições nas leis e regulamentos locais. A utilização de cablagens que não cumpram as especificações pode originar choques eléctricos, fugas eléctricas, fumo e/ou um incêndio.
- Ligue o cabo de terra. (Trabalho de ligação à terra)  
Uma ligação à terra incompleta pode causar choque eléctrico.
- Não ligue os cabos de terra a tubos de gás, tubos de água, pára-raios ou fios de terra de telefone.
- Depois de concluir o trabalho de reparação ou mudança, verifique se os fios de terra estão ligados correctamente.
- Instale um disjuntor eléctrico que cumpra as especificações fornecidas no manual de instalação e as condições nas leis e regulamentos locais.
- Instale o disjuntor eléctrico num local de fácil acesso ao agente.
- Quando instalar um disjuntor eléctrico no exterior, instale um disjuntor concebido para utilizar no exterior.
- O cabo de fornecimento de energia ou o cabo de conexão da unidade interior e exterior não devem ser conectados no meio sob nenhuma circunstância (Conexão usando um terminal sem solda etc.)  
O problema da ligação em locais em que o cabo é conectado no meio pode originar fumo e/ou um incêndio.
- O trabalho de ligação de cabos e fios eléctricos deve ser feito em conformidade com as leis e regulamentos da comunidade em questão e com o manual de instalação.  
Se assim não for, o resultado pode ser electrocussão ou curto-circuito.

### **Teste de funcionamento**

- Antes de utilizar o ar condicionado após a conclusão do trabalho, verifique se a tampa da caixa do equipamento eléctrico da unidade interior e o painel de serviço da unidade exterior estão fechados e coloque o disjuntor eléctrico na posição ON. Pode sofrer um choque eléctrico se ligar a corrente eléctrica sem efectuar primeiro estas verificações.
- Quando detetar algum tipo de problema (como, por exemplo, quando aparecer uma indicação de erro, cheiro a queimado, sons anormais, o ar condicionado não arrefecer ou aquecer, ou existir uma fuga de água) no aparelho de ar condicionado, não toque no ar condicionado, mas coloque o disjuntor eléctrico na posição desligada (OFF) e contacte um técnico de assistência qualificado. Tome as medidas necessárias para garantir que a corrente eléctrica não será ligada (através da colocação do aviso “fora de serviço” junto ao disjuntor de serviço, por exemplo) até chegar o técnico de assistência qualificado. Se continuar a utilizar o ar condicionado com problemas, pode aumentar a ocorrência de problemas mecânicos e provocar choques eléctricos ou outros problemas.
- Depois de terminar o trabalho, certifique-se de que utiliza um aparelho de verificação do isolamento (megaohmímetro de 500 V) para verificar se a resistência é 1 MΩ ou mais entre a secção de carga e a secção metálica sem carga (Secção de ligação à terra). Se o valor da resistência for baixo, ocorre uma fuga ou um choque eléctrico no lado do utilizador.
- Depois de concluir o trabalho de instalação, verifique se existem fugas de refrigerante, a resistência do isolamento e a drenagem de água. Realize um teste para verificar se o ar condicionado está a funcionar correctamente.

### **Explicações fornecidas ao utilizador**

- Depois de concluir o trabalho de instalação, indique o local de instalação do disjuntor eléctrico ao utilizador. Se o utilizador não souber a localização do disjuntor eléctrico, não será capaz de o desligar no caso de ocorrer um problema no ar condicionado.
- Após a instalação, consulte o Manual do proprietário para explicar ao cliente como utilizar e fazer a manutenção da unidade.

### **Mudança**

- Apenas um instalador qualificado (\*1) ou um técnico de assistência qualificado (\*1) pode mudar o ar condicionado. É perigoso o ar condicionado ser mudado por uma pessoa não qualificada porque pode ocorrer um incêndio, choques eléctricos, lesões, fugas de água, ruídos e/ou vibrações.
- Quando efectuar o trabalho de bombagem, encerre o compressor antes de desligar o tubo de refrigerante. Se desligar o tubo do refrigerante com a válvula de serviço ainda aberta e o compressor ainda em funcionamento, faz com que o ar ou outros gases sejam aspirados, aumentando a pressão interna do ciclo de refrigeração para um nível anormalmente elevado, podendo causar a rutura, lesões ou outros problemas.

### **⚠ ATENÇÃO**

#### **Este ar condicionado adotou um refrigerante HFC (R32 ou R410A) que não destrói a camada de ozono.**

- Como o refrigerante R32 ou R410A é facilmente afetado por impurezas, como humidade, película oxidada, óleo, etc., devido à alta pressão, tenha cuidado para não permitir que humidade, sujidade, refrigerante existente, óleo da máquina de refrigeração, etc. se misturem no ciclo de refrigeração durante o trabalho de instalação.
- É necessária uma ferramenta especial para o refrigerante R32 ou R410A para a instalação.
- Use materiais de tubulação para o tubo de conexão novos e limpos, de modo que a humidade e sujidade não se misturem durante o trabalho de instalação.
- Quando usar tubos existentes, siga o manual de instalação fornecido com a unidade exterior.

(\*1) Consulte "Definição de instalador qualificado ou de técnico de assistência qualificado".



Hartelijk dank voor uw aankoop van deze Toshiba-airconditioner.

Lees deze instructies zorgvuldig. Ze bevatten informatie die voldoet aan de richtlijn voor "Machines" (richtlijn 2006/42/EC). Zorg dat u de instructies begrijpt.

Geef na het installeren deze Installatiehandleiding en tevens de bij de buitenunit geleverde Gebruiksaanwijzing aan de klant/gebruiker en vraag hem/haar de documentatie ter referentie op een veilige plaats te bewaren.

#### Algemene beschrijving: Airconditioner

#### Definitie van bevoegd installateur of bevoegd onderhoudsmonteur

De airconditioner moet worden geïnstalleerd, onderhouden, gerepareerd en uiteindelijk weggedaan door een bevoegd installateur of bevoegd onderhoudsmonteur. Wanneer een van deze taken verricht moet worden, verzoekt u een bevoegd installateur of bevoegd onderhoudsmonteur om dit voor u te doen.

Een bevoegd installateur of bevoegd onderhoudsmonteur is een persoon die beschikt over de kennis en bevoegdheden die staan vermeld in de onderstaande tabel.

Persoon	Kennis en competenties waarover de persoon moet beschikken
Bevoegd installateur	<ul style="list-style-type: none"> <li>De bevoegde installateur is een persoon die door Toshiba Carrier Corporation gemaakte airconditioners installeert, onderhoudt, verplaatst en verwijdert. Hij of zij is opgeleid om door Toshiba Carrier Corporation gemaakte airconditioners te installeren, onderhouden, verplaatsen en verwijderen. Deze persoon kan ook iemand zijn die in dergelijke taken is geïnstrueerd door een persoon of personen die zijn opgeleid en heeft dus voldoende kennis voor deze taken.</li> <li>De bevoegde installateur die bevoegd is om het elektrische gedeelte van de installatie, verplaatsing en verwijdering op zich te nemen beschikt over de kwalificaties voor deze elektrische werkzaamheden zoals voorzien in plaatselijke wetten en regelgeving. Deze persoon is opgeleid voor werkzaamheden aan het elektrische systeem van de airconditioners gemaakt door Toshiba Carrier Corporation. Deze persoon kan ook iemand zijn die in dergelijke taken is geïnstrueerd door een persoon of personen die zijn opgeleid en heeft dus voldoende kennis voor dit soort werk.</li> <li>De bevoegde installateur die bevoegd is om het koel- en leidingenwerk van de installatie, verplaatsing en verwijdering op zich te nemen beschikt over de kwalificaties voor deze koel- en leidingenwerkzaamheden zoals voorzien in plaatselijke wetten en regelgeving. Deze persoon is opgeleid voor koel- en leidingenwerkzaamheden aan de airconditioners gemaakt door Toshiba Carrier Corporation. Deze persoon kan ook iemand zijn die in dergelijke taken is geïnstrueerd door een persoon of personen die zijn opgeleid en heeft dus voldoende kennis voor dit soort werk.</li> <li>De bevoegde installateur die bevoegd is om op hoogte te werken is opgeleid om op hoogten te werken met airconditioners gemaakt door Toshiba Carrier Corporation. Deze persoon kan ook iemand zijn die in dergelijke taken is geïnstrueerd door een persoon of personen die zijn opgeleid en heeft dus voldoende kennis voor dit soort werk.</li> </ul>
Bevoegd onderhoudsmonteur	<ul style="list-style-type: none"> <li>De bevoegde onderhoudsmonteur is een persoon die door Toshiba Carrier Corporation gemaakte airconditioners installeert, repareert, onderhoudt, verplaatst en verwijdert. Hij of zij is opgeleid om door Toshiba Carrier Corporation gemaakte airconditioners te installeren, repareren, onderhouden, verplaatsen en verwijderen. Deze persoon kan ook iemand zijn die in dergelijke taken is geïnstrueerd door een persoon of personen die zijn opgeleid en heeft dus voldoende kennis voor deze taken.</li> <li>De bevoegde onderhoudsmonteur die bevoegd is om het elektrische gedeelte van de installatie, reparatie, verplaatsing en verwijdering op zich te nemen beschikt over de kwalificaties voor deze elektrische werkzaamheden zoals voorzien in plaatselijke wetten en regelgeving. Deze persoon is opgeleid voor werkzaamheden aan het elektrische systeem van de airconditioners gemaakt door Toshiba Carrier Corporation. Deze persoon kan ook iemand zijn die in dergelijke taken is geïnstrueerd door een persoon of personen die zijn opgeleid en heeft dus voldoende kennis voor dit soort werk.</li> <li>De bevoegde onderhoudsmonteur die bevoegd is om het koel- en leidingenwerk van de installatie, reparatie, verplaatsing en verwijdering op zich te nemen beschikt over de kwalificaties voor deze koel- en leidingenwerkzaamheden zoals voorzien in plaatselijke wetten en regelgeving. Deze persoon is opgeleid voor koel- en leidingenwerkzaamheden aan de airconditioners gemaakt door Toshiba Carrier Corporation. Deze persoon kan ook iemand zijn die in dergelijke taken is geïnstrueerd door een persoon of personen die zijn opgeleid en heeft dus voldoende kennis voor dit soort werk.</li> <li>De bevoegde onderhoudsmonteur die bevoegd is om op hoogte te werken is opgeleid om op hoogten te werken met airconditioners gemaakt door Toshiba Carrier Corporation. Deze persoon kan ook iemand zijn die in dergelijke taken is geïnstrueerd door een persoon of personen die zijn opgeleid en heeft dus voldoende kennis voor dit soort werk.</li> </ul>

#### Definitie van beschermende kleding



Wanneer de airconditioner wordt vervoerd, geïnstalleerd, onderhouden, gerepareerd of verwijderd, draag beschermende handschoenen en veiligheidswerkklleding.

Draag naast dergelijke normale beschermende kleding de hieronder beschreven beschermende uitrusting bij het uitvoeren van speciale taken zoals aangegeven in onderstaande tabel.

Niet dragen van de juiste beschermende uitrusting is gevaarlijk, omdat u dan meer blootstaat aan letsel, brandwonden, elektrische schokken en andere verwondingen.





Te verrichten werkzaamheden	Beschermende kleding
Alle soorten werk	Werkhandschoenen Veiligheidswerkklleding
Elektrische werkzaamheden	Handschoenen die bescherming bieden tegen elektriciteit Isolerende schoenen Beschermende kleding tegen elektrische schokken
Werk uitgevoerd op hoogte (50 cm of meer)	Veiligheidshelm voor industrieel gebruik
Vervoer van zware voorwerpen	Schoenen met verstevigde neuzen
Reparatie van buiteneenheden	Handschoenen die bescherming bieden tegen elektriciteit

Deze veiligheidsvoorzorgen geven belangrijke informatie over de veiligheid en het voorkomen van lichamelijk letsel van gebruikers en andere personen en het voorkomen van beschadiging van eigendommen. Lees deze handleiding goed door, nadat u de volgende aanwijzingen (betekenis van aanduidingen) hebt gelezen en begrepen en volg de aanwijzingen bestlist op.





Aanduiding	Betekenis van aanduidingen
 <b>WAARSCHUWING</b>	De op deze wijze beschreven aanwijzingen geven aan dat het niet opvolgen van de waarschuwing kan leiden tot ernstig lichamelijk letsel (*1) met mogelijk dodelijke afloop indien het apparaat onjuist wordt gebruikt.
 <b>VOORZICHTIG</b>	De op deze wijze beschreven aanwijzingen geven aan dat het niet opvolgen van de voorzorgen kan leiden tot licht lichamelijk letsel (*2) of beschadiging (*3) van eigendommen indien het apparaat onjuist wordt gebruikt.

- \*1: Ernstig lichamelijk letsel staat voor gezichtsverlies, verwondingen, brandwonden, elektrische schokken, botbreuken, vergiftiging en ander letsel met blijvende gevolgen waarvoor ziekenhuisbehandeling of langdurige ambulante behandeling vereist is.  
\*2: Licht lichamelijk letsel staat voor verwondingen, brandwonden, elektrische schokken en ander letsel waarvoor geen ziekenhuisbehandeling of langdurige ambulante behandeling vereist is.  
\*3: Beschadiging van eigendommen staat voor schade aan gebouwen, huishoudelijke goederen, en verwonding van vee en huisdieren.

#### BETEKENIS VAN SYMBOLEN DIE OP DE UNIT WORDEN WEERGEGEVEN

	<b>WAARSCHUWING</b> (Brandgevaar)	Dit teken is alleen voor R32-koelmiddel. Koelmiddeltype staat geschreven op het naamplaatje van de buitenunit. Als het koelmiddeltype R32 is, gebruikt deze unit een ontvlambaar koelmiddel. Als er koelmiddel lekt en in aanraking komt met vuur of een verwarmingsonderdeel vormt dit schadelijk gas en bestaat er een risico op brand.
		Lees de GEBUIKERSHANDLEIDING zorgvuldig voordat u de apparatuur bedient.
		Servicepersoneel moet voor gebruik aandachtig de GEBUIKERSHANDLEIDING en INSTALLATIEHANDLEIDING lezen.
		Verdere informatie vindt u in de GEBUIKERSHANDLEIDING, INSTALLATIEHANDLEIDING, enz.

## ■ Waarschuwingsaanduidingen op de airconditioner

Waarschuwingsaanduiding	Beschrijving
 <p><b>WARNING</b> <b>ELECTRICAL SHOCK HAZARD</b> Disconnect all remote electric power supplies before servicing.</p>	<p><b>WAARSCHUWING</b> <b>GEVAAR VOOR ELEKTRISCHE SCHOK</b> Verbreek alle externe stroomvoorzieningsaansluitingen alvorens enig onderhoud te verrichten.</p>
 <p><b>WARNING</b> Moving parts. Do not operate unit with grille removed. Stop the unit before the servicing.</p>	<p><b>WAARSCHUWING</b> Bewegende delen. Schakel het apparaat niet in wanneer het rooster is verwijderd. Stop de werking van het apparaat alvorens enig onderhoud te verrichten.</p>
 <p><b>CAUTION</b> High temperature parts. You might get burned when removing this panel.</p>	<p><b>VOORZICHTIG</b> Delen met hoge temperaturen. Bij het verwijderen van dit paneel bestaat de kans dat u zich brandt.</p>
 <p><b>CAUTION</b> Do not touch the aluminum fins of the unit. Doing so may result in injury.</p>	<p><b>VOORZICHTIG</b> Raak de aluminium vinnen van de unit niet aan. Dat kan tot ernstige verwondingen leiden.</p>
 <p><b>CAUTION</b> <b>BURST HAZARD</b> Open the service valves before the operation, otherwise there might be the burst.</p>	<p><b>VOORZICHTIG</b> <b>GEVAAR VOOR BARSTEN</b> Open voor het inschakelen eerst de veiligheidskleppen, anders kunnen leidingen barsten.</p>

# 1 Voorzorgen voor de veiligheid

De fabrikant is niet aansprakelijk voor schade ten gevolge van het niet opvolgen van aanwijzingen in deze handleiding.

## WAARSCHUWING

### Algemeen

- Alvorens u begint met het installeren van de airconditioner, moet u de installatiehandleiding aandachtig doorlezen. Volg alle instructies voor het installeren van de airconditioner op.
- Het installeren mag alleen door een bevoegde installateur of onderhoudsmonteur worden uitgevoerd. Een foute installatie resulteert mogelijk in waterlekage, elektrische schokken of brand.
- Gebruik voor het bijvullen of vervangen geen ander koelmiddel dan het gespecificeerde middel. Er wordt anders namelijk mogelijk abnormaal hoge druk in de koelcyclus opgebouwd met een onjuiste werking, ontploffing of lichamelijk letsel als gevolg.
- Voordat u het inlaatrooster van de binnenunit of het onderhoudspaneel van de buitenunit opent, zet u eerst de stroomonderbreker in de OFF-stand. Als u verzuimt de stroomonderbreker in de OFF-stand te zetten, loopt u de kans op een elektrische schok bij aanraken van de inwendige onderdelen. Alleen een bevoegd installateur (\*1) of een bevoegd onderhoudsmonteur (\*1) mag het inlaatrooster van de binnenunit of het onderhoudspaneel van de buitenunit verwijderen en het vereiste werk verrichten.
- Alvorens u begint met installeren, onderhouden, repareren of verwijderen, zet u eerst de schakelaar in de OFF-stand. Anders kan dit tot elektrische schokken leiden.
- Plaats tijdens het installeren, onderhouden, repareren of verwijderen van het apparaat een bordje "werk in uitvoering" bij de schakelaar. Als de schakelaar per vergissing in de ON-stand staat, loopt u kans op een elektrische schok.
- Alleen een bevoegd installateur (\*1) of een bevoegd onderhoudsmonteur (\*1) mag werkzaamheden op hoogte verrichten met een trapje van 50 cm of meer, of het inlaatrooster van de binnenunit verwijderen om werk te verrichten.
- Draag tijdens het installeren, onderhouden en verwijderen van het apparaat altijd werkhandschoenen en veiligheidskleding.
- Raak de aluminium vinnen van de unit niet aan. Anders kunt u zich eraan verwonden. Als het nodig is de vin aan te raken, trekt u eerst werkhandschoenen en beschermende kleding aan en begint u dan pas met het werk.
- Plaats nooit voorwerpen op de buitenunit en klim er niet bovenop. U kunt er af vallen of een voorwerp kan van de buitenunit vallen en letsel veroorzaken.

- Gebruik voor het werken op hoogte een ladder die voldoet aan de ISO 14122-norm en volg de aanwijzingen in de handleiding van de ladder. Draag als beschermingsmiddel ook een helm voor gebruik in de industrie om het werk uit te voeren.
- Voor schoonmaken van het filter of andere onderdelen van de buitenunit zet u altijd eerst de schakelaar in de OFF-stand en plaatst u een bordje “werk in uitvoering” bij de schakelaar voordat u aan het werk gaat.
- Bij het werken op hoogte dient u voordat u start een waarschuwbord te plaatsen zodat niemand bij uw werkplek komt. Onderdelen en andere voorwerpen kunnen vallen. Dat kan een persoon op de grond letsels toebrengen. Draag tijdens het uitvoeren een helm ter bescherming tegen mogelijk vallende voorwerpen.
- Gebruik geen ander koelmiddel dan R32 of R410A. Voor het koelmiddelttype controleert u de te combineren buitenunit.
- De airconditioner moet stabiel worden getransporteerd. Neem contact op met de dealer, indien onderdelen beschadigd zijn.
- Draag de airconditioner altijd met minimaal 2 personen, indien deze met de hand moet worden verplaatst.
- Verplaats of repareer het apparaat niet zelf. De binnenkant van de unit staat onder hoogspanning. U kunt bij het verwijderen van het deksel en de hoofdunit een elektrische schok krijgen.
- Dit toestel moet worden gebruikt door experts of opgeleide gebruikers in winkels, de lichte industrie of voor commercieel gebruik door leken.

#### **Keuze van de installatieplaats**

- Indien de airconditioner in een kleine ruimte wordt geplaatst, neem dan de nodige maatregelen om te verzekeren dat de concentratie van lekkend koelmiddel in de ruimte de limiet niet kan overschrijden.
- Installeer niet op plaatsen waar ontvlambaar gas kan lekken. Als gas lekt en zich rond de unit ophoopt, kan het ontvlammen en brand veroorzaken.
- Bij het vervoeren van de airconditioner dient u schoeisel met verstevigde neuzen te dragen.
- Bij het vervoeren van de airconditioner mag u deze niet optillen aan de banden rond de verpakkingendoos. U kunt zichzelf kwetsen, mochten de banden breken.
- Installeer de binnenunit ten minste 2,5 m boven de vloer, anders kunnen gebruikers letsel oplopen of een elektrische schok krijgen, als ze hun vingers of andere voorwerpen in de binnenunit steken, terwijl de airconditioner werkt.
- Zet geen verbrandingsapparaat op een plaats waar het in de directe luchtstroom van de airconditioner staat. Anders vindt mogelijk onvolledige verbranding plaats.

- Toestel en leidingwerk moeten worden geïnstalleerd, bediend en opgeslagen in een ruimte met een vloeroppervlak groter dan  $A_{\min} \text{ m}^2$ . Hoe verkrijgt u  $A_{\min} \text{ m}^2$ :  $A_{\min} = (M / (2,5 \times 0,22759 \times h_0))^2$   
M is de ladinghoeveelheid van het koelmiddel in het apparaat in **kg**;  
 $h_0$  is de installatiehoogte van het apparaat in **m**:  
0,6 m voor vloerstaand/1,8 m voor wandmontage/1,0 m voor raammontage/2,2 m voor plafondmontage.  
(Alleen R32-koelmiddelmodellen. Meer informatie vindt u in de installatiehandleiding van de buitenunit.)

#### **Installatie**

- Wanneer de binnenunit moet worden opgehangen, gebruikt u de daarvoor bestemde ophangbouten (M10 of W3/8) en moeren (M10 of W3/8).
- Installeer de airconditioner op een plaats die stevig genoeg is voor het gewicht van de unit. Als dat niet het geval is, kan het apparaat vallen en letsels veroorzaken.
- Volg de instructies in de installatiehandleiding bij het installeren van de airconditioner. Indien u de instructies niet opvolgt, kan de unit vallen of kantelen of kunnen extra ruis, trillingen, waterlekage en andere problemen ontstaan.
- Voer de vereiste installatiewerkzaamheden uit ter bescherming tegen wind, storm en aardbevingen. De airconditioner kan vallen of kantelen en zo ernstige ongelukken veroorzaken, indien deze fout is geïnstalleerd.
- Ventileer de ruimte direct, indien er tijdens het installeren koelmiddel lekt. Indien lekkend koelmiddel in contact komt met vuur, komt mogelijk giftig gas vrij.
- Gebruik een vorkheftruck voor het verplaatsen van de airconditioner-units en een takel of dergelijk geschikt voorwerp voor het installeren.

#### **Koelmiddelleiding**

- Monteer tijdens de installatiewerkzaamheden de koelmiddelleiding nauwkeurig voordat de airconditioner wordt bediend. Als de compressor wordt bediend met de klep open en zonder koelmiddelbuis, zuigt de compressor lucht aan en ontstaat er overdruk in het koelsysteem, hetgeen kan leiden tot verwondingen.
- Draai de flensmoer met een momentsleutel op de voorgeschreven manier aan. Als de flensmoer te krachtig wordt aangedraaid, kan de moer een tijd later barsten, waardoor koelmiddel kan gaan lekken.
- Controleer na het installeren dat er geen koelmiddel lekt. Wanneer gasvormig koelmiddel in de ruimte lekt en in contact komt met open vuur, zoals bij een gasfornuis, kunnen giftige gassen worden gevormd.

- Na het installeren of verplaatsen van de airconditioner volgt u de aanwijzingen in de installatiehandleiding voor het volledig ontluichten van de leidingen, zodat er in het koelsysteem geen ander gas overblijft dan alleen het koelmiddel. Bij onvolledig ontluichten kan de airconditioner niet goed functioneren.
- Gebruik stikstofgas voor de test op luchtdichtheid.
- De oplaadslang moet zo worden aangesloten dat deze niet slap hangt.

### **Elektrische bedrading**

- Alleen een bevoegd installateur (\*1) of een bevoegd onderhoudsmonteur (\*1) mag elektrische werkzaamheden aan de airconditioner verrichten. Onder geen voorwaarde mag dit werk worden verricht door een onbevoegde, aangezien fouten of vergissingen kunnen leiden tot elektrische schokken en/of kortsluiting of lekstroom.
- Bij het aansluiten van de stroomdraden, het repareren van elektrische onderdelen of het verrichten van andere elektrische werkzaamheden dient u handschoenen te dragen ter bescherming tegen elektrische stroom en isolerend schoeisel en kleding ter bescherming tegen elektrische schokken. Als u dergelijke beschermende kleding niet draagt, loopt u de kans op elektrische schokken.
- Gebruik bedrading die voldoet aan de specificaties in de installatiehandleiding en de ter plaatse geldende voorschriften en wetten. Het gebruik van bedrading die niet voldoet aan de specificaties kan resulteren in elektrische schokken, kortsluiting en lekstroom, rookontwikkeling en/of brandgevaar.
- Verbind een aardedraad. (aardaansluitingen)  
Een onvolledige aarding kan een elektrische schok veroorzaken.
- Sluit aardedraden niet aan op gasleidingen, waterleidingen, bliksemafleiders of aardkabels voor telefoons.
- Na het voltooiën van de verplaatsing of het reparatiewerk dient u te controleren of de aardleidingen naar behoren zijn aangesloten.
- Installeer een stroomonderbreker die voldoet aan de specificaties in de installatiehandleiding en de ter plaatse geldende voorschriften en wetten.
- Installeer de stroomonderbreker op een plaats waar die goed toegankelijk is voor de gebruiker.
- Als u de stroomonderbreker buitenshuis aanbrengt, let dan goed op dat het een specifiek voor buitengebruik geschikt type is.
- In geen geval moet de voedingsdraad of de binnen- en buitenverbindingkabel in het midden worden aangesloten (verbinding met behulp van soldeervrije aansluiting, enz.)  
Aansluitprobleem op de plaatsen waar de kabel in het midden is aangesloten, kan tot rookontwikkeling en/of brandgevaar leiden.

- Werkzaamheden met elektrische bedrading moeten altijd worden uitgevoerd in overeenstemming met de plaatselijke regelgeving, wetten en de installatiehandleiding.  
Doet u dit niet, dan kan dat leiden tot elektrocutie of kortsluiting.

### **Testen**

- Nadat u de werkzaamheden hebt voltooid dient u voor het inschakelen van de airconditioner eerst te controleren of het deksel van de elektriciteitskast van de binneneenheid en het onderhoudspaneel van de buiteneenheid zijn gesloten, om vervolgens de stroomonderbreker in de ON-stand te zetten. Als u de stroom inschakelt zonder eerst deze punten te controleren, kunt u een elektrische schok krijgen.
- Indien er iets mis is met de airconditioner (wanneer u een foutmelding ziet of een brandlucht ruikt, vreemde geluiden hoort of wanneer de airconditioner niet koelt of verwarmt, of wanneer er water uit lekt), raak dan de airconditioner niet aan, maar zet de schakelaar in de OFF-stand en neem contact op met een bevoegd onderhoudsmonteur. Neem de nodige maatregelen om te voorkomen dat de stroom wordt ingeschakeld (breng bijvoorbeeld een bordje “defect” aan dicht bij de stroomonderbreker) totdat de bevoegde onderhoudsmonteur arriveert. Het voortzetten van het gebruik van de airconditioner terwijl er iets mis mee is, kan leiden tot ernstige mechanische defecten, elektrische schokken en andere problemen.
- Nadat het werk is voltooid, dient u met een isolatietester (500 V Megger) te controleren of de weerstand 1 MΩ of meer bedraagt tussen de stroomvoerende delen en het niet-stroomvoerende metalen deel (aardingsdeel). Als de weerstandswaarde te gering is, kan er kortsluiting, lekstroom of een elektrische schok optreden aan de gebruikerskant.
- Na voltooiing van het installatiewerk controleert u of er geen koelmiddel lekt, of de waterafvoer in orde is en controleert u de weerstand van de isolatie. Vervolgens laat u de airconditioner proefdraaien, om te zien of het apparaat goed werkt.

### **Uitleg aan de gebruiker**

- Na voltooiing van het installatiewerk vertelt u de gebruiker waar de stroomonderbreker zich bevindt. Als de gebruiker niet weet waar de stroomonderbreker zit, kan hij of zij de airconditioner niet uitschakelen wanneer er zich een storing voordoet in de werking.
- Als de installatie is voltooid, volg dan de Gebruikershandleiding om de klant uit te leggen hoe hij het apparaat moet gebruiken en onderhouden.

---

## Elders opstellen

- Alleen een bevoegd installateur (\*1) of een bevoegd onderhoudsmonteur (\*1) mag de airconditioner verplaatsen. Het is gevaarlijk als een onbevoegde de airconditioner verplaatst, aangezien dat kan leiden tot gevaar voor brand, elektrische schokken, verwondingen, waterlekage, bijgeluiden en/of trillingen.
  - Bij uitvoeren van werkzaamheden wanneer de pomp gestopt is, schakelt u eerst de compressor uit voordat u de koelmiddelbuis losmaakt. Wanneer u de koelmiddelleiding loskoppelt met de onderhoudsklep open en de compressor in bedrijf, wordt lucht en gas opgezogen waardoor de druk binnen de koelcyclus te hoog oploopt, wat mogelijk kan leiden tot barsten, letsel of andere problemen.
- 

---

## VOORZICHTIG

### **Deze airconditioner werkt met het HFC-koelmiddel (R32 of R410A) dat de ozonlaag niet aantast.**

- Aangezien het R32- of R410A-koelmiddel gemakkelijk wordt beïnvloed door verontreinigingen zoals vocht, geoxideerde film, olie, enz., vanwege de hoge druk, moet u ervoor zorgen dat vocht, vuil, bestaand koelmiddel, koelmachineolie, enz. niet vermengd raken in de koelcyclus tijdens de installatiewerkzaamheden.
  - Voor de installatie is een speciaal gereedschap voor het R32- of R410A-koelmiddel vereist.
  - Gebruik nieuw en schoon leidingmateriaal voor de verbindingsspijp zodat vocht en vuil tijdens de installatiewerkzaamheden niet met elkaar worden vermengd.
  - Wanneer u bestaande leidingen gebruikt, volg dan de installatiehandleiding die bij de buitenunit is geleverd.
- 

(\*1) Zie "Definitie van bevoegd installateur of bevoegd onderhoudsmonteur".

Σας ευχαριστούμε για την αγορά του συγκεκριμένου κλιματιστικού της Toshiba.

Διαβάστε προσεκτικά αυτές τις οδηγίες που περιλαμβάνουν σημαντικές πληροφορίες και συμμορφώνονται προς την Οδηγία περί μηχανημάτων (Οδηγία 2006/42/ΕΚ) και βεβαιωθείτε ότι τις κατανοείτε.

Μετά την ολοκλήρωση της εργασίας εγκατάστασης, παραδώστε το παρόν Εγχειρίδιο εγκατάστασης καθώς και το Εγχειρίδιο κατόχου που συνοδεύει την εξωτερική μονάδα στον χρήστη και υποδείξτε του να το φυλάξει σε ασφαλές σημείο για όποτε το χρειαστεί στο μέλλον.

**Γενική ονομασία: Κλιματιστικό**

**Ορισμός ειδικευμένου εγκαταστάτη ή ειδικευμένου τεχνικού σέρβις**

Η εγκατάσταση, η συντήρηση, η επισκευή και η αφαίρεση του κλιματιστικού πρέπει να ανατεθούν σε ειδικευμένο εγκαταστάτη ή ειδικευμένο τεχνικό σέρβις. Όποτε απαιτείται να γίνει οποιαδήποτε από τις εν λόγω εργασίες, αναθέστε την σε ειδικευμένο εγκαταστάτη ή ειδικευμένο τεχνικό σέρβις.

Ο ειδικευμένος εγκαταστάτης ή ειδικευμένος τεχνικός σέρβις είναι αντιπρόσωπος ο οποίος διαθέτει τα προσόντα και τις γνώσεις που περιγράφονται στον παρακάτω πίνακα.

Αντιπρόσωπος	Προσόντα και γνώσεις που απαιτείται να διαθέτει ο αντιπρόσωπος
Ειδικευμένος εγκαταστάτης	<ul style="list-style-type: none"> <li>Ο ειδικευμένος εγκαταστάτης είναι ο τεχνικός που εκτελεί εργασίες εγκατάστασης, συντήρησης, μετεγκατάστασης και αφαίρεσης των κλιματιστικών που κατασκευάζει η Toshiba Carrier Corporation. Έχει καταρτιστεί για την εγκατάσταση, τη συντήρηση, τη μετεγκατάσταση και την αφαίρεση των κλιματιστικών που κατασκευάζει η Toshiba Carrier Corporation ή, εναλλακτικά, του έχουν δοθεί οι ανάλογες οδηγίες από ειδικά καταρτισμένο τεχνικό οπότε γνωρίζει καλά ό,τι έχει σχέση με τις εν λόγω εργασίες.</li> <li>Ο ειδικευμένος εγκαταστάτης που επιτρέπεται να κάνει όσες ηλεκτρολογικές εργασίες έχουν σχέση με την εγκατάσταση, τη μετεγκατάσταση και την αφαίρεση διαθέτει τα προσόντα που απαιτούνται για τις εν λόγω εργασίες όπως καθορίζεται από τους τοπικούς νόμους και κανονισμούς και έχει καταρτιστεί για θέματα που αφορούν τις ηλεκτρολογικές εργασίες σε κλιματιστικά τα οποία κατασκευάζονται από την Toshiba Carrier Corporation ή, εναλλακτικά, του έχουν δοθεί οι ανάλογες οδηγίες από ειδικά καταρτισμένο τεχνικό οπότε γνωρίζει καλά ό,τι έχει σχέση με τις εν λόγω εργασίες.</li> <li>Ο ειδικευμένος εγκαταστάτης που επιτρέπεται να χειρίζεται το ψυκτικό και να εκτελεί τις εργασίες σωλήνωσης που έχουν σχέση με την εγκατάσταση, τη μετεγκατάσταση και την αφαίρεση διαθέτει τα προσόντα που απαιτούνται για τις εν λόγω εργασίες όπως καθορίζεται από τους τοπικούς νόμους και κανονισμούς και έχει καταρτιστεί για θέματα που αφορούν τις εργασίες χειρισμού του ψυκτικού και τις εργασίες σωλήνωσης σε κλιματιστικά τα οποία κατασκευάζονται από την Toshiba Carrier Corporation ή, εναλλακτικά, του έχουν δοθεί οι ανάλογες οδηγίες από ειδικά καταρτισμένο τεχνικό οπότε γνωρίζει καλά ό,τι έχει σχέση με τις εν λόγω εργασίες.</li> <li>Ο ειδικευμένος εγκαταστάτης που επιτρέπεται να εργάζεται σε ψηλά σημεία έχει καταρτιστεί για θέματα που αφορούν τις εργασίες αυτές σε κλιματιστικά τα οποία κατασκευάζονται από την Toshiba Carrier Corporation ή, εναλλακτικά, του έχουν δοθεί οι ανάλογες οδηγίες από ειδικά καταρτισμένο τεχνικό οπότε γνωρίζει καλά ό,τι έχει σχέση με τις εν λόγω εργασίες.</li> </ul>
Ειδικευμένος τεχνικός σέρβις	<ul style="list-style-type: none"> <li>Ο ειδικευμένος τεχνικός σέρβις είναι αυτός που εκτελεί εργασίες εγκατάστασης, επισκευών, συντήρησης, μετεγκατάστασης και αφαίρεσης των κλιματιστικών τα οποία κατασκευάζει η Toshiba Carrier Corporation. Έχει καταρτιστεί για την εγκατάσταση, την επισκευή, τη συντήρηση, τη μετεγκατάσταση και την αφαίρεση των κλιματιστικών που κατασκευάζει η Toshiba Carrier Corporation ή, εναλλακτικά, του έχουν δοθεί οι ανάλογες οδηγίες από ειδικά καταρτισμένο τεχνικό οπότε γνωρίζει καλά ό,τι έχει σχέση με τις εν λόγω εργασίες.</li> <li>Ο ειδικευμένος τεχνικός σέρβις που επιτρέπεται να κάνει όσες ηλεκτρολογικές εργασίες έχουν σχέση με την εγκατάσταση, την επισκευή, τη μετεγκατάσταση και την αφαίρεση διαθέτει τα προσόντα που απαιτούνται για τις εν λόγω εργασίες όπως καθορίζεται από τους τοπικούς νόμους και κανονισμούς και έχει καταρτιστεί για θέματα που αφορούν τις ηλεκτρολογικές εργασίες σε κλιματιστικά τα οποία κατασκευάζονται από την Toshiba Carrier Corporation ή, εναλλακτικά, του έχουν δοθεί οι ανάλογες οδηγίες από ειδικά καταρτισμένο τεχνικό οπότε γνωρίζει καλά ό,τι έχει σχέση με τις εν λόγω εργασίες.</li> <li>Ο ειδικευμένος τεχνικός σέρβις που επιτρέπεται να χειρίζεται το ψυκτικό και να εκτελεί τις εργασίες σωλήνωσης που έχουν σχέση με την εγκατάσταση, την επισκευή, τη μετεγκατάσταση και την αφαίρεση διαθέτει τα προσόντα που απαιτούνται για τις εν λόγω εργασίες όπως καθορίζεται από τους τοπικούς νόμους και κανονισμούς και έχει καταρτιστεί για θέματα που αφορούν τις εργασίες χειρισμού του ψυκτικού και τις εργασίες σωλήνωσης σε κλιματιστικά τα οποία κατασκευάζονται από την Toshiba Carrier Corporation ή, εναλλακτικά, του έχουν δοθεί οι ανάλογες οδηγίες από ειδικά καταρτισμένο τεχνικό οπότε γνωρίζει καλά ό,τι έχει σχέση με τις εν λόγω εργασίες.</li> <li>Ο ειδικευμένος τεχνικός σέρβις που επιτρέπεται να εργάζεται σε ψηλά σημεία έχει καταρτιστεί για θέματα που αφορούν τις εργασίες αυτές σε κλιματιστικά τα οποία κατασκευάζονται από την Toshiba Carrier Corporation ή, εναλλακτικά, του έχουν δοθεί οι ανάλογες οδηγίες από ειδικά καταρτισμένο τεχνικό οπότε γνωρίζει καλά ό,τι έχει σχέση με τις εν λόγω εργασίες.</li> </ul>

**Ορισμός εξοπλισμού προστασίας**



Κατά τη μεταφορά, την εγκατάσταση, τη συντήρηση, την επισκευή ή την αφαίρεση του κλιματιστικού πρέπει να φοράτε προστατευτικά γάντια και προστατευτική στολή εργασίας.

Κατά την εκτέλεση των ειδικών εργασιών που περιγράφονται αναλυτικά στον παρακάτω πίνακα εκτός από τον συνήθη προστατευτικό εξοπλισμό, πρέπει να φοράτε και αυτόν που περιγράφεται παρακάτω.

Αν παραλείψετε να φορέσετε τον σωστό προστατευτικό εξοπλισμό, θέτετε τον εαυτό σας σε κίνδυνο καθώς θα είστε πιο ευάλωτοι σε τραυματισμούς, εγκαύματα, ηλεκτροπληξία και άλλους τραυματισμούς.





Εκτελούμενη εργασία	Χρήση εξοπλισμού προστασίας
Κάθε τύπος εργασίας	Προστατευτικά γάντια Προστατευτική στολή εργασίας
Ηλεκτρολογικές εργασίες	Προστατευτικά γάντια ηλεκτρολόγων Μονωτικά παπούτσια Στολή προστασίας από ηλεκτροπληξία
Εργασία σε ψηλά σημεία (άνω των 50 εκατοστών)	Κράνη βιομηχανικής χρήσης
Μεταφορά βαρέων αντικειμένων	Υποδήματα με πρόσθετη προστασία στα δάχτυλα
Επισκευή εξωτερικής μονάδας	Προστατευτικά γάντια ηλεκτρολόγων

Οι συγκεκριμένες προφυλάξεις ασφαλείας περιγράφουν σημαντικά ζητήματα που αφορούν θέματα ασφαλείας προς αποφυγή τραυματισμού των χρηστών και άλλων ατόμων και πρόκλησης υλικών ζημιών. Διαβάστε όλο το παρόν εγχειρίδιο αφού κατανοήσετε το παρακάτω περιεχόμενο (τις επεξηγήσεις των ενδείξεων) και φροντίστε να ακολουθήσετε κάθε περιγραφή.





Ένδειξη	Επεξήγηση ένδειξης
 ΠΡΟΕΙΔΟΠΟΙΗΣΗ	Το κείμενο που επισημαίνεται με τον τρόπο αυτό υποδεικνύει ότι σε περίπτωση μη τήρησης των οδηγιών που παρατίθενται με την ένδειξη «Προειδοποίηση» υπάρχει κίνδυνος σοβαρής σωματικής βλάβης (*1) ή θανάσιμου τραυματισμού αν δεν χειριστείτε το προϊόν με τον ενδεδειγμένο τρόπο.
 ΠΡΟΣΟΧΗ	Το κείμενο που επισημαίνεται με τον τρόπο αυτό υποδεικνύει ότι σε περίπτωση μη τήρησης των οδηγιών που παρατίθενται με την ένδειξη «Προσοχή» υπάρχει κίνδυνος ελαφρού τραυματισμού (*2) ή υλικής ζημιάς (*3) αν δεν χειριστείτε το προϊόν με τον ενδεδειγμένο τρόπο.

\*1: Ο όρος «σοβαρή σωματική βλάβη» σημαίνει απώλεια όρασης, τραυματισμό, εγκαύματα, ηλεκτροπληξία, κάταγμα, δηλητηρίαση και άλλους τραυματισμούς που έχουν συνέπειες και απαιτούν νοσοκομειακή περίθαλψη ή μακροχρόνια θεραπεία εκτός νοσοκομείου.  
 \*2: Ο όρος «ελαφρός τραυματισμός» σημαίνει τραυματισμό, εγκαύματα, ηλεκτροπληξία και άλλους τραυματισμούς που δεν απαιτούν νοσοκομειακή περίθαλψη ούτε μακροχρόνια θεραπεία εκτός νοσοκομείου.  
 \*3: Ο όρος «υλική ζημία» σημαίνει ζημία σε κτήρια και επιπτώσεις σε νοικοκυριά, οικόσται ζωά και κατοικίδια.

**ΣΗΜΑΣΙΑ ΤΩΝ ΣΥΜΒΟΛΩΝ ΠΟΥ ΑΝΑΓΡΑΦΟΝΤΑΙ ΣΤΗ ΜΟΝΑΔΑ**

	<b>ΠΡΟΕΙΔΟΠΟΙΗΣΗ</b> (Κίνδυνος πυρκαγιάς)	Αυτό το σήμα αφορά μόνο το ψυκτικό R32. Ο τύπος ψυκτικού είναι γραμμένος στην πινακίδα προδιαγραφών της εξωτερικής μονάδας. Σε περίπτωση που ο τύπος ψυκτικού είναι R32, η συγκεκριμένη μονάδα χρησιμοποιεί εύφλεκτο ψυκτικό. Αν το ψυκτικό διαρρέει και έρθει σε επαφή με φωτιά ή θερμαινόμενο τμήμα, θα δημιουργηθούν επιβλαβή αέρια και υπάρχει κίνδυνος πυρκαγιάς.
	Διαβάστε το ΕΓΧΕΙΡΙΔΙΟ ΚΑΤΟΧΟΥ προσεκτικά πριν από τη λειτουργία.	
	Το προσωπικό του σέρβις απαιτείται να διαβάσει προσεκτικά το ΕΓΧΕΙΡΙΔΙΟ ΚΑΤΟΧΟΥ και το ΕΓΧΕΙΡΙΔΙΟ ΕΓΚΑΤΑΣΤΑΣΗΣ πριν από τη λειτουργία.	
	Περισσότερες πληροφορίες είναι διαθέσιμες στο ΕΓΧΕΙΡΙΔΙΟ ΚΑΤΟΧΟΥ και το ΕΓΧΕΙΡΙΔΙΟ ΕΓΚΑΤΑΣΤΑΣΗΣ, και τα παρόμοια.	

## ■ Προειδοποιητικές ενδείξεις στη μονάδα του κλιματιστικού

Προειδοποιητική ένδειξη	Περιγραφή
 <p><b>WARNING</b> <b>ELECTRICAL SHOCK HAZARD</b> Disconnect all remote electric power supplies before servicing.</p>	<p><b>ΠΡΟΕΙΔΟΠΟΙΗΣΗ</b> <b>ΚΙΝΔΥΝΟΣ ΗΛΕΚΤΡΟΠΛΗΞΙΑΣ</b> Πριν από τις εργασίες σέρβις αποσυνδέστε όλες τις απομακρυσμένες πηγές παροχής ηλεκτρικού ρεύματος.</p>
 <p><b>WARNING</b> Moving parts. Do not operate unit with grille removed. Stop the unit before the servicing.</p>	<p><b>ΠΡΟΕΙΔΟΠΟΙΗΣΗ</b> Κινούμενα εξαρτήματα. Μη θέσετε τη μονάδα σε λειτουργία αν έχετε αφαιρέσει τη γρίλια. Διακόψτε τη λειτουργία της μονάδας πριν από εργασίες σέρβις.</p>
 <p><b>CAUTION</b> High temperature parts. You might get burned when removing this panel.</p>	<p><b>ΠΡΟΣΟΧΗ</b> Εξαρτήματα με υψηλή θερμοκρασία. Κατά την αφαίρεση αυτού του πλαισίου υπάρχει κίνδυνος να πάθετε εγκαύματα.</p>
 <p><b>CAUTION</b> Do not touch the aluminum fins of the unit. Doing so may result in injury.</p>	<p><b>ΠΡΟΣΟΧΗ</b> Μην αγγίζετε τα αλουμινένια πτερύγια της μονάδας. Διατρέχετε κίνδυνο τραυματισμού.</p>
 <p><b>CAUTION</b> <b>BURST HAZARD</b> Open the service valves before the operation, otherwise there might be the burst.</p>	<p><b>ΠΡΟΣΟΧΗ</b> <b>ΚΙΝΔΥΝΟΣ ΕΚΡΗΞΗΣ</b> Ανοίξτε τις βαλβίδες σέρβις πριν από τη λειτουργία, διαφορετικά ενδέχεται να προκληθεί έκρηξη.</p>

# 1 Προφυλάξεις για ασφάλεια

Ο κατασκευαστής δεν αναλαμβάνει ευθύνη για τυχόν βλάβες ή θάνατο προκληθούν από αμέλεια συμμόρφωσης με τα όσα περιγράφονται στο παρόν εγχειρίδιο.

## ΠΡΟΕΙΔΟΠΟΙΗΣΗ

### Γενικά

- Πριν ξεκινήσετε με την εγκατάσταση του κλιματιστικού, διαβάστε με προσοχή το Εγχειρίδιο εγκατάστασης και ακολουθήστε τις οδηγίες για την εγκατάσταση του κλιματιστικού.
- Οι εργασίες εγκατάστασης επιτρέπεται να εκτελούνται μόνο από ειδικευμένο εγκαταστάτη ή ειδικευμένο τεχνικό σέρβις. Αν η εγκατάσταση δεν γίνει με τον ενδεδειγμένο τρόπο, υπάρχει κίνδυνος διαρροών νερού, ηλεκτροπληξίας ή πυρκαγιάς.
- Μη χρησιμοποιήσετε διαφορετικό ψυκτικό από το προβλεπόμενο για συμπλήρωση ή αντικατάσταση. Αλλιώς ενδέχεται να αναπτυχθεί ασυνήθιστα υψηλή πίεση στον κύκλο ψύξης οπότε υπάρχει κίνδυνος βλάβης ή έκρηξης του προσίοντος ή τραυματισμού σας.
- Πριν ανοίξετε τη γρίλια εισαγωγής της εσωτερικής μονάδας ή του πίνακα σέρβις της εξωτερικής μονάδας, φέρτε τον αυτόματο διακόπτη κυκλώματος στη θέση OFF. Αν δεν φέρετε τον αυτόματο διακόπτη κυκλώματος στη θέση OFF, υπάρχει κίνδυνος ηλεκτροπληξίας λόγω τυχαίας επαφής με τα εξαρτήματα στο εσωτερικό της μονάδας. Η αφαίρεση της γρίλιας εισαγωγής της εσωτερικής μονάδας ή του πίνακα σέρβις της εξωτερικής μονάδας και η εκτέλεση των απαιτούμενων εργασιών επιτρέπεται να γίνουν μόνο από ειδικευμένο εγκαταστάτη (\*1) ή ειδικευμένο τεχνικό σέρβις (\*1).
- Πριν από την εκτέλεση εργασιών εγκατάστασης, συντήρησης, επισκευών ή αφαίρεσης, φέρτε τον αυτόματο διακόπτη κυκλώματος στη θέση OFF. Αλλιώς υπάρχει κίνδυνος ηλεκτροπληξίας.
- Τοποθετήστε σήμα με την ένδειξη «Εκτελούνται εργασίες.» κοντά στον αυτόματο διακόπτη κυκλώματος όση ώρα εκτελούνται εργασίες εγκατάστασης, συντήρησης, επισκευής ή αφαίρεσης. Υπάρχει κίνδυνος ηλεκτροπληξίας αν ο αυτόματος διακόπτης κυκλώματος έρθει τυχαία στη θέση ON.
- Μόνον ειδικευμένος εγκαταστάτης (\*1) ή ειδικευμένος τεχνικός σέρβις (\*1) επιτρέπεται να αναλαμβάνει την εκτέλεση εργασιών σε ψηλά σημεία χρησιμοποιώντας βάση στήριξης ύψους τουλάχιστον 50 εκατοστών ή να αφαιρεί τη γρίλια εισαγωγής της εσωτερικής μονάδας για την εκτέλεση εργασιών.
- Πρέπει να φοράτε προστατευτικά γάντια και προστατευτική στολή εργασίας κατά την εκτέλεση εργασιών εγκατάστασης, σέρβις και αφαίρεσης.
- Μην αγγίζετε το αλουμινένιο πτερύγιο της μονάδας. Διατρέχετε κίνδυνο τραυματισμού. Αν πρέπει να αγγίξετε το πτερύγιο για κάποιο λόγο, φορέστε πρώτα προστατευτικά γάντια και προστατευτική στολή εργασίας.
- Δεν πρέπει να σκαρφαλώνετε επάνω στην εξωτερική μονάδα ούτε να τοποθετείτε αντικείμενα στο επάνω μέρος της. Υπάρχει κίνδυνος να πέσετε ή να πέσουν τα αντικείμενα και να προκληθεί τραυματισμός.

- Όποτε εκτελείτε εργασία σε ψηλά σημεία, χρησιμοποιήστε σκάλα που συμμορφώνεται προς το πρότυπο ISO 14122 και ακολουθήστε τη διαδικασία που παρατίθεται στις οδηγίες για τη σκάλα. Επίσης, φορέστε κράνος βιομηχανικής χρήσης ως εξοπλισμό προστασίας προτού εκτελέσετε την εργασία.
- Πριν από τον καθαρισμό του φίλτρου ή άλλων εξαρτημάτων της εξωτερικής μονάδας, φέρτε οπωσδήποτε τον αυτόματο διακόπτη στη θέση OFF και τοποθετήστε σήμα με την ένδειξη «Εκτελούνται εργασίες.» κοντά στον αυτόματο διακόπτη προτού προχωρήσετε στην εργασία.
- Προτού εκτελέσετε εργασίες σε ψηλά σημεία, τοποθετήστε σε περίοπτη θέση ένα σχετικό σήμα ώστε να μην πλησιάσει κανείς εκεί. Εξαρτήματα και άλλα αντικείμενα ενδέχεται να πέσουν από ψηλά και να τραυματίσουν όποιον βρίσκεται από κάτω. Κατά την εκτέλεση των εργασιών πρέπει να φοράτε κράνος για να προστατευτείτε από αντικείμενα που ίσως πέσουν.
- Μη χρησιμοποιείτε ψυκτικό μέσο άλλο εκτός του R32 ή του R410A. Για τον τύπο του ψυκτικού μέσου, ελέγξτε την εξωτερική μονάδα που πρόκειται να συνδυαστεί.
- Πρέπει να διασφαλίζετε την ευστάθεια του κλιματιστικού κατά τη μεταφορά του. Αν κάποιο εξάρτημα του προϊόντος είναι σπασμένο, επικοινωνήστε με τον αντιπρόσωπο.
- Όποτε πρέπει να μεταφέρετε το κλιματιστικό με τα χέρια, πρέπει να είστε δύο ή περισσότερα άτομα.
- Δεν πρέπει να μετακινείτε ούτε να επισκευάζετε οποιαδήποτε μονάδα μόνιμα. Υπάρχει υψηλή τάση στο εσωτερικό της μονάδας. Όταν αφαιρέσετε το κάλυμμα και την κεντρική μονάδα, διατρέχετε κίνδυνος ηλεκτροπληξίας.
- Η συγκεκριμένη συσκευή προορίζεται για χρήση από έμπειρους ή καταρτισμένους χρήστες στον κλάδο της ελαφράς βιομηχανίας ή για εμπορική χρήση από μη ειδικούς.

### Επιλογή θέσης εγκατάστασης

- Όταν το κλιματιστικό είναι τοποθετημένο σε μικρό χώρο, πάρτε τα κατάλληλα μέτρα για να διασφαλίσετε ότι η συγκέντρωση διαρροής ψυκτικού στον χώρο δεν υπερβαίνει το κρίσιμο επίπεδο.
- Μην εγκαταστήσετε τη μονάδα σε χώρο όπου υπάρχει πιθανότητα διαρροής εύφλεκτου αερίου. Σε περίπτωση διαρροής αερίου και συσσώρευσής του γύρω από τη μονάδα υπάρχει κίνδυνος ανάφλεξής του και πυρκαγιάς.
- Για να μεταφέρετε το κλιματιστικό, πρέπει να φοράτε υποδήματα με πρόσθετη προστασία στα δάχτυλα.
- Για να μεταφέρετε το κλιματιστικό, δεν πρέπει να πιάσετε από τα τσέρκια που υπάρχουν γύρω από το χαρτοκιβώτιο της συσκευασίας του. Αν τυχόν σπάσουν οι ταινίες, διατρέχετε κίνδυνο τραυματισμού.
- Εγκαταστήστε την εσωτερική μονάδα τουλάχιστον 2,5 μέτρα πάνω από το δάπεδο γιατί αλλιώς οι χρήστες υπάρχει κίνδυνος να τραυματιστούν ή να πάθουν ηλεκτροπληξία αν περάσουν τα δάχτυλά τους ή άλλα αντικείμενα μέσα στην εσωτερική μονάδα την ώρα που το κλιματιστικό βρίσκεται σε λειτουργία.
- Μην τοποθετήσετε συσκευή καύσης σε σημείο που είναι άμεσα εκτεθειμένο στη ροή του αέρα από το κλιματιστικό γιατί ενδέχεται να είναι ατελής η καύση.

- Η συσκευή και οι σωληνώσεις πρέπει να εγκαθίστανται, να λειτουργούν και να αποθηκεύονται σε δωμάτιο με επιφάνεια δαπέδου μεγαλύτερη από  $A_{\min} \text{ m}^2$ .  
 Πώς να έχετε  $A_{\min} \text{ m}^2$ :  $A_{\min} = (M / (2,5 \times 0,22759 \times h_0))^2$   
 M είναι η ποσότητα πλήρωσης ψυκτικού στη συσκευή σε **kg**.  
 $h_0$  είναι το ύψος εγκατάστασης της συσκευής σε **m**:  
 0,6 m για όρθια στο δάπεδο/1,8 m για τοποθέτηση σε τοίχο/1,0 m για τοποθέτηση σε παράθυρο/2,2 m για τοποθέτηση σε οροφή.  
 (Μόνο τα μοντέλα ψυκτικού μέσου R32. Για λεπτομέρειες, ανατρέξτε στο Εγχειρίδιο Εγκατάστασης της εξωτερικής μονάδας.)

### Εγκατάσταση

- Όταν η εσωτερική μονάδα προορίζεται για ανάρτηση, επιβάλλεται η χρήση των καθορισμένων κοχλιών ανάρτησης (M10 ή W3/8) και των περικοχλίων (M10 ή W3/8).
- Εγκαταστήστε το κλιματιστικό με ασφάλεια σε σημείο όπου η βάση του να μπορεί να στηρίξει επαρκώς το βάρος του. Αν τα σημεία αυτά δεν έχουν αρκετή αντοχή, υπάρχει κίνδυνος να πέσει η μονάδα και να προκληθεί τραυματισμός.
- Για να εγκαταστήσετε το κλιματιστικό, ακολουθήστε τις οδηγίες που παρατίθενται στο Εγχειρίδιο εγκατάστασης. Αν δεν ακολουθήσετε τις οδηγίες αυτές, υπάρχει κίνδυνος πτώσης ή ανατροπής του προϊόντος ή πρόκλησης θορύβου, δόνησης, διαρροής νερού ή άλλων προβλημάτων.
- Εκτελέστε πιστά τις καθορισμένες εργασίες εγκατάστασης για να διασφαλίσετε ότι ο εξοπλισμός θα αντέξει σε ισχυρούς ανέμους ή σεισμό. Αν η εγκατάσταση του κλιματιστικού δεν γίνει με τον ενδεδειγμένο τρόπο, υπάρχει κίνδυνος ανατροπής ή πτώσης κάποιας μονάδας οπότε θα προκληθεί ατύχημα.
- Σε περίπτωση διαρροής του ψυκτικού αερίου κατά τη διάρκεια των εργασιών εγκατάστασης, αερίστε αμέσως τον χώρο. Αν το ψυκτικό αέριο που έχει διαρρεύσει έρθει σε επαφή με φωτιά, υπάρχει κίνδυνος έκλυσης βλαβερού αερίου.
- Χρησιμοποιήστε περονοφόρο ανυψωτικό για να μεταφέρετε τα εξαρτήματα του κλιματιστικού και βαρούλκο ή παλάγκο για την εγκατάστασή τους.

### Σωλήνωση ψυκτικού

- Εγκαταστήστε το σωλήνα ψυκτικού με ασφάλεια στη διάρκεια της εργασίας εγκατάστασης πριν θέσετε σε λειτουργία το κλιματιστικό. Εάν ο συμπιεστής λειτουργήσει με τη βαλβίδα ανοιχτή και χωρίς σωλήνα ψυκτικού υγρού, ο συμπιεστής αναρροφά αέρα και ο κύκλος ψύξης υπερσυμπιέζεται, πράγμα το οποίο ενδέχεται να προκαλέσει τραυματισμό.
- Σφίξτε το ρακόρ με ροπόκλειδο με τον καθορισμένο τρόπο. Αν σφίξετε υπερβολικά το ρακόρ, υπάρχει κίνδυνος να ραγίσει μετά από μεγάλο χρονικό διάστημα οπότε ίσως προκληθεί διαρροή του ψυκτικού.
- Μετά τις εργασίες εγκατάστασης, βεβαιωθείτε ότι δεν υπάρχει διαρροή του ψυκτικού αερίου. Σε περίπτωση διαρροής του ψυκτικού αερίου στον χώρο και ροής του κοντά σε πηγή φωτιάς, π.χ. εστία κουζίνας, ενδέχεται να δημιουργηθούν βλαβερές αναθυμιάσεις.



- Όταν ολοκληρωθεί η εγκατάσταση ή η μετεγκατάσταση του κλιματιστικού, ακολουθήστε τις οδηγίες που παρατίθενται στο Εγχειρίδιο εγκατάστασης για πλήρη εξαέρωση ώστε στον κύκλο ψύξης να μην αναμειγνύονται άλλα αέρια εκτός του ψυκτικού. Αν δεν κάνετε πλήρη εξαέρωση, ενδέχεται να προκληθεί δυσλειτουργία του κλιματιστικού.
- Απαιτείται η χρήση αερίου αζώτου για τη δοκιμή της αεροστεγανότητας.
- Πρέπει να συνδέσετε τον εύκαμπτο σωλήνα πλήρωσης έτσι ώστε να μην είναι χαλαρός.

### Ηλεκτρική καλωδίωση

- Η εκτέλεση των ηλεκτρολογικών εργασιών στο κλιματιστικό επιτρέπεται μόνο από ειδικευμένο εγκαταστάτη (\*1) ή ειδικευμένο τεχνικό σέρβις (\*1). Σε καμία περίπτωση δεν επιτρέπεται η εκτέλεση των εν λόγω εργασιών από ανειδίκευτο άτομο επειδή αν οι εργασίες δεν εκτελεστούν όπως πρέπει υπάρχει κίνδυνος ηλεκτροπληξίας και/ή διαρροών ρεύματος.
- Για να συνδέσετε τα καλώδια ρεύματος, την επισκευή ηλεκτρολογικών μερών ή άλλες εργασίες ηλεκτρολογικής φύσης, να φοράτε μονωτικά γάντια (ηλεκτρολόγου), μονωτικά υποδήματα και ενδυμασία για προστασία έναντι ηλεκτροπληξίας. Η μη χρήση του συγκεκριμένου εξοπλισμού προστασίας ενδέχεται να καταλήξει σε ηλεκτροπληξία.
- Χρησιμοποιήστε καλωδιώσεις οι οποίες πληρούν τις προδιαγραφές που παρατίθενται στο Εγχειρίδιο εγκατάστασης και τις διατάξεις των τοπικών κανονισμών και νόμων. Αν χρησιμοποιήσετε καλωδιώσεις που δεν πληρούν τις προδιαγραφές, υπάρχει κίνδυνος ηλεκτροπληξίας, διαρροών ρεύματος, καπνού και/ή πυρκαγιάς.
- Συνδέστε το καλώδιο γείωσης. (Εργασίες γείωσης)  
Η ατελής γείωση μπορεί να οδηγήσει σε ηλεκτροπληξία.
- Δεν πρέπει να συνδέσετε τα καλώδια γείωσης με σωλήνες φυσικού αερίου, σωλήνες νερού και αγωγό αλεξικέραυνου ούτε με σύρματα γείωσης τηλεφωνικής γραμμής.
- Μετά την ολοκλήρωση της εργασίας επισκευής ή μετεγκατάστασης, ελέγξτε αν τα σύρματα γείωσης είναι συνδεδεμένα όπως πρέπει.
- Εγκαταστήστε διακόπτη κυκλώματος ο οποίος πληροί τις προδιαγραφές που παρατίθενται στο Εγχειρίδιο εγκατάστασης και τις απαιτήσεις των τοπικών κανονισμών και νόμων.
- Εγκαταστήστε τον διακόπτη κυκλώματος σε σημείο στο οποίο θα μπορεί να αποκτήσει εύκολα πρόσβαση ο αντιπρόσωπος.
- Οπότε χρειαστεί να εγκαταστήσετε τον διακόπτη κυκλώματος σε εξωτερικό χώρο, φροντίστε να είναι σχεδιασμένος για την εν λόγω χρήση.
- Σε καμία περίπτωση, το καλώδιο τροφοδοσίας ή το καλώδιο σύνδεσης της εσωτερικής και της εξωτερικής μονάδας δεν πρέπει να συνδεθεί στη μέση (Σύνδεση με χρήση ακροδέκτη χωρίς συγκόλληση κλπ.)  
Τυχόν προβλήματα σύνδεσης στα σημεία, όπου το καλώδιο συνδέεται στη μέση, ενδέχεται να προκαλέσουν καπνό ή/και πυρκαγιά.

- Οι εργασίες ηλεκτρικής καλωδίωσης πρέπει να εκτελούνται σύμφωνα με τους νόμους και κανονισμούς που ισχύουν σε κάθε κοινότητα και με βάση το εγχειρίδιο εγκατάστασης.  
Αλλιώς υπάρχει κίνδυνος ηλεκτροπληξίας ή βραχυκυκλώματος.

### Δοκιμαστική λειτουργία

- Μόλις ολοκληρωθούν οι εργασίες και πριν θέσετε το κλιματιστικό σε λειτουργία, ελέγξτε αν έχετε κλείσει το κάλυμμα του κουτιού ηλεκτρικού ελέγχου της εσωτερικής μονάδας και τον πίνακα σέρβις της εξωτερικής μονάδας και φέрте τον διακόπτη κυκλώματος στη θέση ON. Αν ενεργοποιήσετε την παροχή ρεύματος χωρίς να πραγματοποιήσετε τους ελέγχους αυτούς, διατρέχετε κίνδυνο ηλεκτροπληξίας.
- Αν έχει παρουσιαστεί πρόβλημα οιοδήποτε είδους στο κλιματιστικό (π.χ. ένδειξη σφάλματος, οσμή καμένου, ασυνήθιστοι θόρυβοι, αποτυχία ψύξης ή θέρμανσης ή διαρροή νερού), μην αγγίζετε το κλιματιστικό αλλά φέрте τον διακόπτη κυκλώματος στη θέση OFF και επικοινωνήστε με ειδικευμένο τεχνικό. Πάρτε μέτρα για να διασφαλίσετε ότι δεν θα είναι εφικτή η ενεργοποίηση της παροχής ρεύματος (π.χ. αναρτώντας πινακίδα με την ένδειξη «εκτός λειτουργίας» κοντά στον διακόπτη κυκλώματος) ωστόσο φτάσει ο ειδικευμένος τεχνικός σέρβις. Αν συνεχίσετε να χρησιμοποιείτε το κλιματιστικό μηχάνημα παρόλο που παρουσιάζει πρόβλημα, υπάρχει κίνδυνος επιδείνωσης των μηχανικών προβλημάτων ή πρόκλησης ηλεκτροπληξίας ή άλλων προβλημάτων.
- Μόλις ολοκληρωθούν οι εργασίες, χρησιμοποιήστε κατάλληλη συσκευή για τον έλεγχο της μόνωσης (500 V Megger) για να ελέγξετε εάν η αντίσταση είναι 1 MΩ ή περισσότερο μεταξύ ηλεκτροφόρου τμήματος και μη ηλεκτροφόρου μεταλλικού τμήματος (τμήμα γείωσης). Εάν η τιμή αντίστασης είναι χαμηλή, θα προκληθεί σοβαρή ζημιά στην πλευρά του χρήστη, όπως διαρροή ρεύματος ή ηλεκτροπληξία.
- Μόλις ολοκληρωθούν οι εργασίες εγκατάστασης, ελέγξτε μήπως υπάρχουν διαρροές του ψυκτικού και επιθεωρήστε την αντίσταση της μόνωσης και τον σωλήνα αποστράγγισης του νερού. Ύστερα θέστε το κλιματιστικό σε δοκιμαστική λειτουργία για να ελέγξετε αν λειτουργεί όπως πρέπει.

### Επεξηγήσεις που παρέχονται στο χρήστη

- Μόλις ολοκληρωθούν οι εργασίες εγκατάστασης, πείτε στον χρήστη που βρίσκεται ο διακόπτης κυκλώματος. Αν ο χρήστης δεν γνωρίζει πού βρίσκεται ο διακόπτης κυκλώματος, δεν θα μπορέσει να τον απενεργοποιήσει στην περίπτωση που θα προκύψει κάποιο πρόβλημα στο κλιματιστικό.
- Μετά τις εργασίες εγκατάστασης ακολουθήστε τις οδηγίες που παρατίθενται στο Εγχειρίδιο κατόχου για να εξηγήσετε στον πελάτη πώς πρέπει να χρησιμοποιεί και να συντηρεί τη μονάδα.

### Μετεγκατάσταση

- Η μετεγκατάσταση του κλιματιστικού επιτρέπεται να εκτελείται μόνον από ειδικευμένο εγκαταστάτη (\*1) ή ειδικευμένο τεχνικό σέρβις (\*1). Αν η μετεγκατάσταση του κλιματιστικού γίνει από ανειδίκευτο άτομο, υπάρχει κίνδυνος να πυρκαγιάς, ηλεκτροπληξίας, τραυματισμού, διαρροής νερού, θορύβου και/ή δόνησης.
- Κατά την εκτέλεση εργασιών άντλησης διακόψτε τη λειτουργία του συμπιεστή προτού αποσυνδέσετε τον σωλήνα του ψυκτικού. Αν αποσυνδέσετε τον σωλήνα του ψυκτικού έχοντας αφήσει ανοιχτή τη βαλβίδα λειτουργίας και ενώ συνεχίζει να λειτουργεί ο συμπιεστής, θα προκληθούν αναρρόφηση αέρα ή άλλου αερίου, αύξηση της πίεσης εντός του κύκλου ψύξης σε μη φυσιολογικά υψηλά επίπεδα και ενδεχομένως ράγισμα, τραυματισμός ή άλλα προβλήματα.

### ΠΡΟΣΟΧΗ

**Στο συγκεκριμένο Κλιματιστικό έχει υιοθετηθεί η χρήση ψυκτικού HFC (R32 ή R410A) που δεν καταστρέφει τη στιβάδα του όζοντος.**

- Καθώς το ψυκτικό μέσο R32 ή R410A επηρεάζεται εύκολα από ακαθαρσίες όπως υγρασία, οξειδωμένο φιλμ, λάδι κλπ., λόγω της υψηλής πίεσης, προσέξτε να μην επιτραπεί η ανάμιξη υγρασίας, ακαθαρσιών, υπάρχοντος ψυκτικού, ψυκτικού ελαίου κλπ. κατά τη διάρκεια των εργασιών εγκατάστασης.
- Απαιτείται ένα ειδικό εργαλείο για το ψυκτικό R32 ή R410A για την εγκατάσταση.
- Χρησιμοποιήστε ένα νέο και καθαρό υλικό σωληνώσεων για τον σωλήνα σύνδεσης, έτσι ώστε η υγρασία και οι ακαθαρσίες να μην αναμιγνύονται μαζί κατά τη διάρκεια των εργασιών εγκατάστασης.
- Όταν χρησιμοποιείτε τις υπάρχουσες σωληνώσεις, ακολουθείτε το εγχειρίδιο εγκατάστασης που παρέχεται μαζί με την εξωτερική μονάδα.

(\*1) Ανατρέξτε στην ενότητα «Ορισμός ειδικευμένου εγκαταστάτη ή ειδικευμένου τεχνικού σέρβις».

Благодарим вас за приобретение кондиционера Toshiba. Внимательно прочтите данные инструкции, так как в них содержится важная информация, соответствующая директиве «Оборудование» (Директива 2006/42/EC), и убедитесь, что они вам понятны. После завершения установки передайте пользователю это руководство по установке и входящее в комплект наружного блока руководство по эксплуатации и попросите пользователя хранить эти материалы в надежном месте для использования в будущем.

#### Общее обозначение: кондиционер воздуха

#### Определение квалифицированного монтажника или квалифицированного специалиста по обслуживанию

Этот кондиционер должен устанавливаться, обслуживаться, ремонтироваться и демонтироваться квалифицированным монтажником или квалифицированным специалистом по обслуживанию. При необходимости выполнения какой-либо из этих операций обратитесь к квалифицированному монтажнику или специалисту по обслуживанию.

Квалифицированный монтажник или квалифицированный специалист по обслуживанию — это лицо, имеющее квалификацию и знания, указанные в таблице ниже.

Лицо	Необходимые квалификация и знания
Квалифицированный монтажник	<ul style="list-style-type: none"> <li>Квалифицированный монтажник — это лицо, которое устанавливает, обслуживает, перемещает и демонтирует кондиционеры производства компании Toshiba Carrier Corporation. Это лицо прошло обучение операциям установки, технического обслуживания, переустановки и демонтажа кондиционеров производства компании Toshiba Carrier Corporation либо получило инструктаж по выполнению таких операций от лица или лиц, прошедших необходимое обучение и знакомых с указанными операциями во всех деталях.</li> <li>Квалифицированный монтажник, допущенный к выполнению необходимых электротехнических работ при установке, переустановке и демонтаже, имеет соответствующую этим работам квалификацию, предусмотренную местным законодательством и нормативами, и представляет собой лицо, обученное вопросам выполнения электротехнических работ, связанных с кондиционерами производства компании Toshiba Carrier Corporation, либо получившее инструктаж по таким вопросам от лица или лиц, прошедших необходимое обучение и знакомых с указанными работами во всех деталях.</li> <li>Квалифицированный монтажник, допущенный к выполнению необходимых работ с хладагентом и прокладке трубок хладагента при установке, переустановке и демонтаже, имеет соответствующую этим работам квалификацию, предусмотренную местным законодательством и нормативами, и представляет собой лицо, обученное вопросам прокладки трубок хладагента и обращения с хладагентом, связанным с кондиционерами производства компании Toshiba Carrier Corporation, либо получившее инструктаж по таким вопросам от лица или лиц, прошедших необходимое обучение и знакомых с указанными работами во всех деталях.</li> <li>Квалифицированный монтажник, допущенный к выполнению высотных работ, прошел обучение по вопросам высотных работ с кондиционерами производства компании Toshiba Carrier Corporation либо получил инструктаж по таким вопросам от лица или лиц, прошедших необходимое обучение и знакомых с указанными работами во всех деталях.</li> </ul>
Квалифицированный специалист по обслуживанию	<ul style="list-style-type: none"> <li>Квалифицированный специалист по обслуживанию — это лицо, которое устанавливает, ремонтирует, обслуживает, перемещает и демонтирует кондиционеры производства компании Toshiba Carrier Corporation. Это лицо прошло обучение операциям установки, ремонта, технического обслуживания, переустановки и демонтажа кондиционеров производства компании Toshiba Carrier Corporation либо получило инструктаж по выполнению таких операций от лица или лиц, прошедших необходимое обучение и знакомых с указанными операциями во всех деталях.</li> <li>Квалифицированный специалист по обслуживанию, допущенный к выполнению необходимых электротехнических работ при установке, ремонте, переустановке и демонтаже, имеет соответствующую этим работам квалификацию, предусмотренную местным законодательством и нормативами, и представляет собой лицо, обученное вопросам выполнения электротехнических работ, связанных с кондиционерами производства компании Toshiba Carrier Corporation, либо получившее инструктаж по таким вопросам от лица или лиц, прошедших необходимое обучение и знакомых с указанными работами во всех деталях.</li> <li>Квалифицированный специалист по обслуживанию, допущенный к выполнению необходимых работ с хладагентом и прокладке трубок хладагента при установке, ремонте, переустановке и демонтаже, имеет соответствующую этим работам квалификацию, предусмотренную местным законодательством и нормативами, и представляет собой лицо, обученное вопросам прокладки трубок хладагента и обращения с хладагентом, связанным с кондиционерами производства компании Toshiba Carrier Corporation, либо получившее инструктаж по таким вопросам от лица или лиц, прошедших необходимое обучение и знакомых с указанными работами во всех деталях.</li> <li>Квалифицированный специалист по обслуживанию, допущенный к выполнению высотных работ, прошел обучение по вопросам высотных работ с кондиционерами производства компании Toshiba Carrier Corporation либо получил инструктаж по таким вопросам от лица или лиц, прошедших необходимое обучение и знакомых с указанными работами во всех деталях.</li> </ul>



#### Определение средств индивидуальной защиты

При перевозке, установке, техническом обслуживании, ремонте или демонтаже кондиционера следует носить защитные перчатки и спецодежду.





В дополнение к обычным средствам индивидуальной защиты при выполнении специальных работ, перечисленных в таблице ниже, нужно пользоваться указанными ниже средствами индивидуальной защиты. Если не используются надлежащие средства индивидуальной защиты, возрастает опасность получения травм, ожогов, поражения электрическим током и других повреждений.

Выполняемая работа	Необходимые средства индивидуальной защиты
Все типы работы	Защитные перчатки Защитная рабочая спецодежда
Работы, связанные с электричеством	Защитные перчатки для электриков Изоляционные ботинки Одежда, обеспечивающая защиту от поражения электрическим током
Работы, выполняемые на высоте (50 см или выше)	Промышленная каска
Переноска тяжелых предметов	Ботинки с дополнительным защитным носком
Ремонт наружных блоков	Защитные перчатки для электриков





Данные меры предосторожности касаются важных вопросов обеспечения безопасности для предотвращения травм пользователей и прочих лиц, а также материального ущерба. Перед прочтением данного руководства уясните приведенную ниже информацию (значение условных обозначений) и неукоснительно соблюдайте описанные меры.

Обозначение	Значение обозначения
 <b>ВНИМАНИЕ</b>	Такое обозначение текста указывает на то, что несоблюдение приведенных указаний и ненадлежащее обращение с изделием могут привести к получению тяжелого телесного повреждения (*1) или гибели.
 <b>ОСТОРОЖНО</b>	Такое обозначение текста указывает на то, что несоблюдение приведенных указаний и ненадлежащее обращение с изделием могут привести к получению незначительной травмы (*2) или нанесению материального ущерба (*3).
	*1: Под тяжелыми телесными повреждениями подразумеваются потеря зрения, травмы, ожоги, поражения электрическим током, переломы костей, отравления и другие повреждения, после которых остаются последствия и требуются госпитализация или долгосрочное амбулаторное лечение. *2: Под незначительными травмами подразумеваются травмы, ожоги, поражения электрическим током и другие повреждения, после которых не требуется госпитализация или долгосрочное амбулаторное лечение. *3: Под материальным ущербом подразумевается ущерб, наносимый зданиям, домашнему имуществу, домашнему скоту и домашним животным.

#### ЗНАЧЕНИЯ СИМВОЛОВ, ОТОБРАЖЕННЫХ НА БЛОКЕ

	<b>ПРЕДУПРЕЖДЕНИЯ</b> (Опасность пожара)	Этот знак только для хладагента R32. Тип хладагента указан на паспортной табличке наружного блока. В случае, если тип хладагента – R32, этот блок использует воспламеняющийся хладагент.
	Перед эксплуатацией внимательно прочитайте РУКОВОДСТВО ПОЛЬЗОВАТЕЛЯ.	Если хладагент протекает и контактирует с огнем или нагревательной частью, это создает вредный газ, который может стать причиной возгорания.
	Перед эксплуатацией обслуживающий персонал должен внимательно прочитать РУКОВОДСТВО ПОЛЬЗОВАТЕЛЯ и ИНСТРУКЦИЮ ПО УСТАНОВКЕ.	
	Дополнительная информация доступна в РУКОВОДСТВЕ ПОЛЬЗОВАТЕЛЯ, ИНСТРУКЦИИ ПО УСТАНОВКЕ и тому подобных документах.	

## ■ Предупреждающие знаки на кондиционере

Предупреждающий знак	Описание		
 <table border="1"> <tr> <td><b>WARNING</b></td> </tr> <tr> <td><b>ELECTRICAL SHOCK HAZARD</b> Disconnect all remote electric power supplies before servicing.</td> </tr> </table>	<b>WARNING</b>	<b>ELECTRICAL SHOCK HAZARD</b> Disconnect all remote electric power supplies before servicing.	<p><b>ВНИМАНИЕ</b></p> <p><b>ОПАСНОСТЬ ПОРАЖЕНИЯ ЭЛЕКТРИЧЕСКИМ ТОКОМ</b> Перед обслуживанием отключайте все внешние источники электроэнергии.</p>
<b>WARNING</b>			
<b>ELECTRICAL SHOCK HAZARD</b> Disconnect all remote electric power supplies before servicing.			
 <table border="1"> <tr> <td><b>WARNING</b></td> </tr> <tr> <td>Moving parts. Do not operate unit with grille removed. Stop the unit before the servicing.</td> </tr> </table>	<b>WARNING</b>	Moving parts. Do not operate unit with grille removed. Stop the unit before the servicing.	<p><b>ВНИМАНИЕ</b></p> <p>Движущиеся части. Не эксплуатируйте устройство со снятой решеткой. Перед обслуживанием останавливайте устройство.</p>
<b>WARNING</b>			
Moving parts. Do not operate unit with grille removed. Stop the unit before the servicing.			
 <table border="1"> <tr> <td><b>CAUTION</b></td> </tr> <tr> <td>High temperature parts. You might get burned when removing this panel.</td> </tr> </table>	<b>CAUTION</b>	High temperature parts. You might get burned when removing this panel.	<p><b>ОСТОРОЖНО</b></p> <p>Горячие детали. При снятии этой панели можно получить ожог.</p>
<b>CAUTION</b>			
High temperature parts. You might get burned when removing this panel.			
 <table border="1"> <tr> <td><b>CAUTION</b></td> </tr> <tr> <td>Do not touch the aluminum fins of the unit. Doing so may result in injury.</td> </tr> </table>	<b>CAUTION</b>	Do not touch the aluminum fins of the unit. Doing so may result in injury.	<p><b>ОСТОРОЖНО</b></p> <p>Не касайтесь алюминиевого оребрения на устройстве. Это может привести к травме.</p>
<b>CAUTION</b>			
Do not touch the aluminum fins of the unit. Doing so may result in injury.			
 <table border="1"> <tr> <td><b>CAUTION</b></td> </tr> <tr> <td><b>BURST HAZARD</b> Open the service valves before the operation, otherwise there might be the burst.</td> </tr> </table>	<b>CAUTION</b>	<b>BURST HAZARD</b> Open the service valves before the operation, otherwise there might be the burst.	<p><b>ОСТОРОЖНО</b></p> <p><b>ОПАСНОСТЬ РАЗРЫВА</b> Перед выполнением операций открывайте клапаны обслуживания, иначе возможен разрыв.</p>
<b>CAUTION</b>			
<b>BURST HAZARD</b> Open the service valves before the operation, otherwise there might be the burst.			

# 1 Меры предосторожности

Производитель не несет ответственности за ущерб, вызванный несоблюдением инструкций, приведенных в данном руководстве.

## ВНИМАНИЕ

### Общие меры предосторожности

- Прежде чем приступить к установке кондиционера, внимательно прочтите руководство по установке и в процессе работы соблюдайте изложенные в нем инструкции.
- Выполнение работы по установке разрешается только квалифицированному монтажнику или квалифицированному специалисту по обслуживанию. Неправильная установка может привести к утечке воды, поражению электрическим током или воспламенению.
- Запрещается использовать для пополнения или замены хладагент, отличный от указанного. В противном случае в контуре охлаждения может образоваться аномально высокое давление, что может привести к поломке или взрыву изделия, а также вызвать травмы.
- Прежде чем открывать решетку воздухозаборника внутреннего блока или служебную панель наружного блока, переведите сетевой выключатель в положение OFF (ВЫКЛ.). Если сетевой выключатель не переведен в положение OFF (ВЫКЛ.), возможно поражение электрическим током при контакте с внутренними узлами кондиционера. Снимать решетку воздухозаборника внутреннего блока или служебную панель наружного блока и выполнять необходимые работы разрешается только квалифицированным монтажникам (\*1) или квалифицированным специалистам по обслуживанию (\*1).
- Перед выполнением работ по установке, техническому обслуживанию, ремонту или демонтажу переводите сетевой выключатель в положение OFF (ВЫКЛ.). В противном случае возможно поражение электрическим током.
- На время выполнения работ по установке, обслуживанию, ремонту или демонтажу кондиционера рядом с сетевым выключателем следует поместить знак «Ведутся работы». Если кто-либо по ошибке установит выключатель в положение ON (ВКЛ.), возможно поражение работающего электрическим током.
- Работать на подставке высотой 50 см или более и снимать решетку воздухозаборника внутреннего блока для выполнения работ разрешается только квалифицированному монтажнику (\*1) или квалифицированному специалисту по обслуживанию (\*1).
- При установке, обслуживании и демонтаже следует пользоваться защитными перчатками и спецодеждой.
- Не касайтесь алюминиевого оребрения на устройстве. В противном случае можно получить травму. Если нужно зачем-либо коснуться оребрения, сначала наденьте защитные перчатки и спецодежду, а затем продолжайте работу.
- Запрещается залезать на наружный блок или класть на него какие-либо предметы. Вследствие вашего падения или падения предметов с наружного блока возможно получение травмы.

- При работе на высоте необходимо пользоваться лестницей, отвечающей требованиям стандарта ISO 14122, и следовать указаниям в инструкции к лестнице. При выполнении работ также нужно надевать промышленную каску.
- Перед очисткой фильтров или других узлов наружного блока обязательно переводите сетевой выключатель в положение OFF (ВЫКЛ.) и перед началом работ размещайте рядом с ним знак «Ведутся работы».
- Перед началом высотных работ выставляйте предупреждающий знак, чтобы никто не приближался к зоне проведения работ. Детали или другие предметы могут упасть сверху и нанести травму людям, находящимся внизу. Во время выполнения работы необходимо носить каску для защиты от падающих предметов.
- Не используйте другие хладагенты кроме R32 или R410A. Проверьте тип хладагента, который используется в добавляемом наружном блоке.
- При перевозке кондиционер должен находиться в устойчивом положении. В случае повреждения какой-либо части изделия обратитесь к дилеру.
- Переноску кондиционера должны осуществлять не менее двух человек.
- Не перемещайте блоки и не выполняйте их ремонт самостоятельно. Внутри блока находятся компоненты под высоким напряжением. При снятии крышки и основного блока возможно поражение электрическим током.
- Прибор предназначен для использования специалистами или обученными пользователями в магазинах, в легкой промышленности, а также для коммерческого использования неспециалистами.

### Выбор места установки

- При установке кондиционера в небольшом помещении необходимо принять надлежащие меры, чтобы не допустить превышения предельной концентрации хладагента в случае его утечки.
- Запрещается устанавливать изделие в месте, где возможны утечки горючего газа. В случае утечки газа и концентрации его вокруг блока газ может воспламениться и стать причиной пожара.
- При транспортировке кондиционера необходимо надевать ботинки с дополнительным защитным носком.
- При транспортировке кондиционера не беритесь за обвязку вокруг картонной упаковки. Если обвязка лопнет, вы можете получить травму.
- Устанавливать кондиционер следует на высоте не менее 2,5 м от пола, так как в противном случае пользователи могут получить поражение электрическим током или травму, если их пальцы или другие предметы попадут во внутренний блок работающего кондиционера.
- Не устанавливайте никакие топливосжигающие устройства в местах, где на них будет непосредственно попадать воздушный поток от кондиционера, так как это может приводить к неполному сгоранию.

- Прибор и трубы необходимо устанавливать, эксплуатировать и хранить в помещении с общей площадью более  $A_{\text{мин.}}$  м<sup>2</sup>.  
Как получить  $A_{\text{мин.}}$  м<sup>2</sup>:  $A_{\text{мин.}} = (M / (2,5 \times 0,22759 \times v_0))^2$   
M представляет собой количество хладагента в приборе в кг;  
 $v_0$  – высота установки прибора в м:  
0,6 м для напольной установки / 1,8 м для настенного монтажа / 1,0 м для оконного монтажа / 2,2 м для потолочного монтажа.  
(Только для моделей с хладагентом R32. Подробную информацию см. в руководстве по установке наружного блока.)

### Установка

- Для подвешивания внутреннего блока нужно использовать специально предназначенные для этого подвесные болты (M10 или W3/8) и гайки (M10 или W3/8).
- Кондиционер следует надежно устанавливать на основании, достаточно прочном, чтобы выдержать его вес. Если прочности недостаточно, то блок может упасть, нанеся травму.
- При установке кондиционера следуйте указаниям руководства по установке. Несоблюдение этих инструкций может привести к падению или опрокидыванию изделия, появлению шума, вибрации, утечки воды и другим поломкам.
- При установке примите меры для защиты от сильного ветра и землетрясений. В случае ненадлежащей установки кондиционера блок может упасть или опрокинуться и стать причиной несчастного случая.
- В случае утечки хладагента во время монтажных работ немедленно проветрите помещение. При контакте хладагента с огнем может образоваться токсичный газ.
- Перевозить блоки кондиционера следует с помощью вилочного погрузчика, а поднимать на месте установки — с помощью подъемника или лебедки.

### Трубопровод хладагента

- Перед началом эксплуатации кондиционера надежно смонтируйте и закрепите трубопровод. Если компрессор работает с открытым клапаном и без трубопровода, компрессор засасывает воздух и в контуре охлаждения давление поднимается выше нормы, что может привести к травмированию окружающих.
- Затягивайте конусную гайку динамометрическим ключом в указанном порядке. Чрезмерная затяжка конусной гайки может привести к тому, что со временем на ней образуется трещина, которая может привести к утечке хладагента.
- По окончании монтажных работ убедитесь в отсутствии утечек хладагента. Если при утечке хладагента в помещении его поток проходит в непосредственной близости от источника огня, например, кухонной плиты, возможно образование токсичного газа.

- При установке и переустановке кондиционера соблюдайте инструкции, приведенные в руководстве по установке, и полностью удаляйте воздух из контура хладагента, чтобы никакие газы не смешивались в нем с хладагентом. Если не удалить воздух полностью, это может привести к неполадкам в работе кондиционера.
- Для проверки на герметичность используйте азот.
- Загрузочный шланг нужно подсоединять без слабины.

### **Электропроводка**

- Проводить электротехнические работы с кондиционером разрешается только квалифицированному монтажнику (\*1) или квалифицированному специалисту по обслуживанию (\*1). Ни при каких обстоятельствах эти работы нельзя поручать неквалифицированным лицам, иначе при неправильном выполнении работ возможны поражения электрическим током и/или утечка электроэнергии.
- При подключении электропроводки, ремонте электрических узлов или выполнении других электротехнических работ нужно надевать защитные перчатки для электриков, изолирующие ботинки и одежду, чтобы защититься от поражения электрическим током. Если этого не сделать, возможно поражение электрическим током.
- Используйте электропроводку, которая отвечает техническим характеристикам, приведенным в данном руководстве по установке, а также местным нормативам и требованиям законодательства. Использование электропроводки, не отвечающей техническим требованиям, может привести к поражению электрическим током, утечкам электроэнергии, задымлению и/или пожару.
- Выполняйте подключение провода заземления (работы по заземлению). Невыполнение заземления может стать причиной поражения электрическим током.
- Не подсоединяйте провода заземления к газопроводным и водопроводным трубам, громоотводам и проводам заземления телефонных линий.
- По окончании ремонтных работ или работ по переустановке кондиционера убедитесь в правильности подсоединения проводов заземления.
- Пользуйтесь сетевыми выключателями, которые отвечают техническим характеристикам, приведенным в данном руководстве по установке, а также местным нормативам и требованиям законодательства.
- Устанавливать сетевой выключатель нужно в легкодоступном месте.
- При установке наружных сетевых выключателей нужно использовать такие их типы, которые предназначены для установки вне помещений.
- Ни при каких обстоятельствах не следует подключать силовой кабель или соединительный провод внутреннего и наружного блоков посередине (подключение с помощью разъёмной клеммы и т. д.). Нарушение соединения в местах подключения провода посередине может вызвать задымление и/или пожар.

- Работы по прокладке электропроводки должны выполняться в соответствии с местным законодательством и нормативами и отвечать требованиям руководства по установке. В противном случае возможно поражение электрическим током или короткое замыкание.

### **Испытание**

- Перед тем, как запускать кондиционер после окончания работ с ним, убедитесь, что закрыты крышка электрического блока управления внутреннего блока и служебная панель наружного блока, и переведите сетевой выключатель в положение ON (ВКЛ.). При включении питания без предварительного выполнения указанных проверок возможно поражение электрическим током.
- Если возникли какие-либо неполадки в работе кондиционера (например, отобразился код проверки, появился запах гари, слышны странные звуки, кондиционер не охлаждает или не нагревает воздух, подтекает вода), не прикасайтесь к кондиционеру, переведите его сетевой выключатель в положение OFF (ВЫКЛ.) и вызовите квалифицированного специалиста по обслуживанию. Позаботьтесь, чтобы до прибытия квалифицированного специалиста по обслуживанию не включалось электропитание кондиционера (например, разместите рядом с сетевым выключателем знак «Не работает»). Дальнейшая эксплуатация неисправного кондиционера может привести к усугублению механических проблем, поражению электрическим током или возникновению других неисправностей.
- По окончании работ воспользуйтесь устройством для проверки изоляции (мегаомметром на 500 В) для проверки того, что сопротивление между участком под напряжением и участком не под напряжением (заземлением) равно 1 МОм или более. Если сопротивление мало, это значит, что на стороне пользователя произошла утечка электричества или пробой.
- По завершении установочных работ проверьте наличие утечек хладагента, сопротивление изоляции и слив воды. Затем выполните пробный пуск, чтобы удостовериться в правильной работе кондиционера.

### **Пояснения для пользователя**

- По завершении установочных работ покажите пользователю, где находится сетевой выключатель. Если пользователь не знает расположения сетевого выключателя, он не сможет выключить его в случае проблем с кондиционером.
- Выполнив установочные работы, объясните клиенту правила эксплуатации и обслуживания устройства в соответствии с руководством пользователя.

### Переустановка на другое место

- Переустанавливать кондиционер разрешается только квалифицированному монтажнику (\*1) или квалифицированному специалисту по обслуживанию (\*1). В результате переустановки кондиционера неквалифицированным лицом возможны пожар, поражение электрическим током, травмы, утечка воды, шум и/или вибрация.
- При выполнении сливных работ нужно остановить компрессор до отсоединения трубопровода хладагента. Отсоединение трубопровода хладагента при открытом клапане обслуживания и работающем компрессоре приведет к подосу воздуха или другого газа, в результате чего давление в контуре охлаждения достигнет аномально высокого уровня, что может привести к разрыву контура, травме или другим проблемам.









### ОСТОРОЖНО

**В данном кондиционере используется хладагент на основе ГФУ (R32 или R410A), не разрушающий озоновый слой.**

- Поскольку на хладагент R32 или R410A легко воздействуют примеси, такие как влага, окисленная пленка, масло и т. д., из-за высокого давления, будьте осторожны, чтобы не допустить попадания влаги, грязи, имеющегося хладагента, масла в холодильных машинах и т. д. в контур охлаждения во время монтажных работ.
- Для установки хладагента R32 или R410A требуется специальный инструмент.
- Используйте новые и чистые трубопроводные материалы для соединения труб, чтобы в процессе монтажа не смешивались влага и грязь.
- При использовании имеющихся труб следуйте руководству по установке, прилагаемому к наружному блоку.

(\*1) См. раздел «Определение квалифицированного монтажника или квалифицированного специалиста по обслуживанию».

## 2 Accessory parts

Part name	Qty	Shape	Usage
Owner's Manual	1		(Hand over to customers) (For other languages that do not appear in this Installation Manual, please refer to the enclosed CD-R.)
Installation Manual	1	This manual	(Hand over to customers) (For other languages that do not appear in this Installation Manual, please refer to the enclosed CD-R.)
CD-ROM	1	—	Owner's Manual and Installation Manual
Heat insulating pipe	2		For heat insulation of the pipe connecting section
Installation pattern	1	—	For checking of ceiling opening and the main unit position
Installation gauge	2		For positioning of the ceiling position (To be used with the installation pattern)
Heat insulator	1		For heat insulation of drain connecting section
Eccentric washer	4		For unit hanging
Washer	4		For unit hanging
Hose band	2		For connecting drain pipe
Flexible hose	1		For adjusting core-out of drain pipe

### ■ Separate sold parts

The Ceiling panel and remote controller are sold separately. For the installation of these products, follow the Installation Manuals supplied with them.

## 3 Selection of installation place

### WARNING

- **Install the air conditioner securely in a location where the base can sustain the weight adequately.**  
If the strength is not enough, the unit may fall down resulting in injury.
- **Install the air conditioner at a height 2.5 m or more from the floor.**  
If you insert your hands or others directly into the unit while the air conditioner operates, it is dangerous because you may contact with revolving fan or active electricity.

### CAUTION

- **Do not install in a location where flammable gas may leaks are possible.**  
If the gas leak and accumulate around the unit, it may ignite and cause a fire.

**Upon approval of the customer, install the air conditioner in a place that satisfies the following conditions.**

- Place where the unit can be installed horizontally.
- Place where a sufficient servicing space can be ensured for safety maintenance and check.
- Place where drained water will not cause any problem.

**Avoid installing in the following places.**

- Place exposed to air with high salt content (seaside area), or place exposed to large quantities of sulfide gas (hot spring).  
(The unit should be used in these places, special protective measures are needed.)
- A restaurant kitchen where a lot of oil is used or place near machines in a factory (Oil adhering to the heat exchanger and resin part (turbo fan) in the indoor unit may reduce the performance, generate mist or dew drop, or deform or damage resin parts.)
- Places where iron or other metal dust is present. If iron or other metal dust adheres to or collects on the interior of the air conditioner, it may spontaneously combust and start a fire.
- Place where organic solvent is used nearby.
- Place close to a machine generating high frequency.
- Place where the discharged air blows directly into the window of the neighbour house. (Outdoor unit)
- Place where noise of the outdoor unit is easily transmitted.  
(When the outdoor unit is installed on the boundary with the neighbour, pay due attention to the level of noise.)
- Place with poor ventilation. (Before air duct work, check whether value of fan speed, static pressure and duct resistance are correct.)
- Do not use the air conditioner for special purposes such as preserving food, precision instruments, or art objects, or where breeding animals or growing plants are kept. (This may degrade the quality of preserved materials.)
- Place where any of high-frequency appliances (including inverter devices, private power generators, medical equipment, and communication equipment) and inverter-type fluorescent light is installed.  
(A malfunction of the air conditioner, abnormal control, or problems due to noise to such appliances / equipment may occur.)
- When the wireless remote controller is used in a room equipped with an inverter-type fluorescent light or at a place exposed to direct sunlight, signals from the remote controller may not be received correctly.
- Place where organic solvent is used.
- Place near a door or window exposed to humid outside air (Dew drop may form.).
- Place where special spray is used frequently.



## ■ Installation space

Ensure there is sufficient space to install the unit and to perform maintenance work as and when required. Keep 15 mm or more for clearance between top plate of the indoor unit and the ceiling surface.

Unit: mm

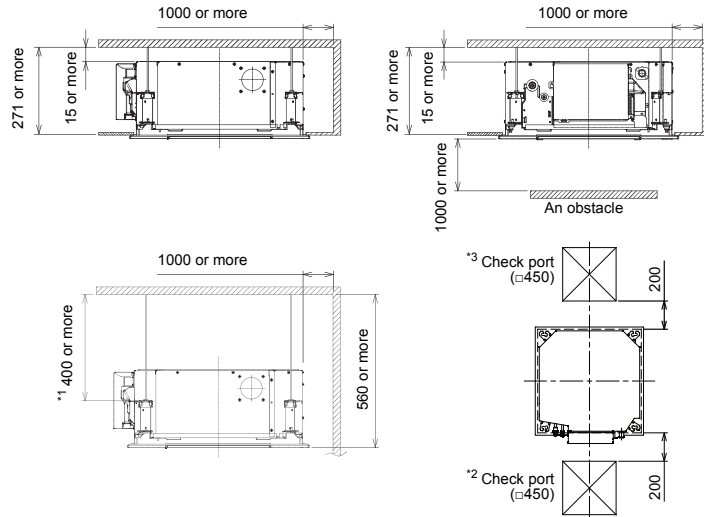

### REQUIREMENT

- \*1 If there is no ceiling board, the length of the hanging bolt shall be more than 400 mm.
- \*2 Set a service check opening panel at electrical control box side of the unit (size: 450 × 450 mm or more) for piping, maintenance, and servicing.
- \*3 For the adjustment of the installation height of the indoor unit.

## ■ Selection of installation place

Continual operation of the indoor unit under high-humidity conditions as described below, dew may condense and water may drop.

Especially, high-humidity atmosphere (dew point temperature: 23 °C or more) may generate dew inside the ceiling.

1. Unit is installed inside the ceiling with slated roof.
2. Unit is installed at a location using inside of the ceiling as fresh air intake path.
3. Kitchen

### REQUIREMENT

When the humidity inside the ceiling seems to be higher than 80%, attach a heat insulator to the side (top) surface of the indoor unit. (Use a heat insulator with a thickness of 10 mm or more.)

## ■ Ceiling height

Unit : m

Model RAV-	Installable ceiling height
RM30 type	Up to 2.7
RM40, 56 type	Up to 3.5

When the height of the ceiling exceeds the distance of the item Standard / 4-way in below table, the warm air is difficult to reach the floor.

It is necessary to change the setup value of the high ceiling setting or discharge direction.

### ▼ Height list of ceiling possible to be installed

Unit : m

Indoor unit Capacity type	RM30 type	RM40 type	RM56 type	Setup of high ceiling
Discharge direction	4-way	4-way	4-way	Setup data
Standard (Factory default)	2.7	2.9	3.2	0000
High ceiling (1)	—	3.2	3.4	0001
High ceiling (3)	—	3.5	3.5	0003

### REQUIREMENT

When high ceiling (1) or (3) is used with 4-way blowing, a draft is easily recognized due to drop of discharge temperature.

The lighting time of the filter sign (notification of filter cleaning) on the remote controller can be changed according to installation conditions.

When it is difficult to obtain satisfactory heating due to location place of the indoor unit or the structure of the room, the detection temperature of heating can be raised.

Refer to "8. Applicable controls" in this manual for the setting procedure.

# 4 Installation

## REQUIREMENT

- Strictly comply with the following rules to prevent damage of the indoor units and human injury.
- Do not put a heavy article on the indoor unit. (Even units are packaged)
  - Carry in the indoor unit as it is packaged if possible. If carrying in the indoor unit unpacked by necessity, use buffering cloth or other soft cloth to not damage the unit.
  - To move the indoor unit, hold the hooking metals (4 positions) only.
  - Do not apply force to the other parts (refrigerant pipe, drain pan, foamed parts, or resin parts).
  - Carry the package by two or more persons, and do not bundle it with plastic band at positions other than specified.

## External view

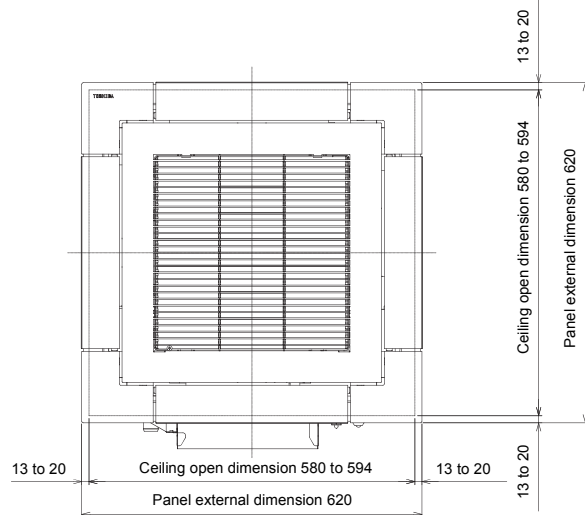

## External view

Unit: mm

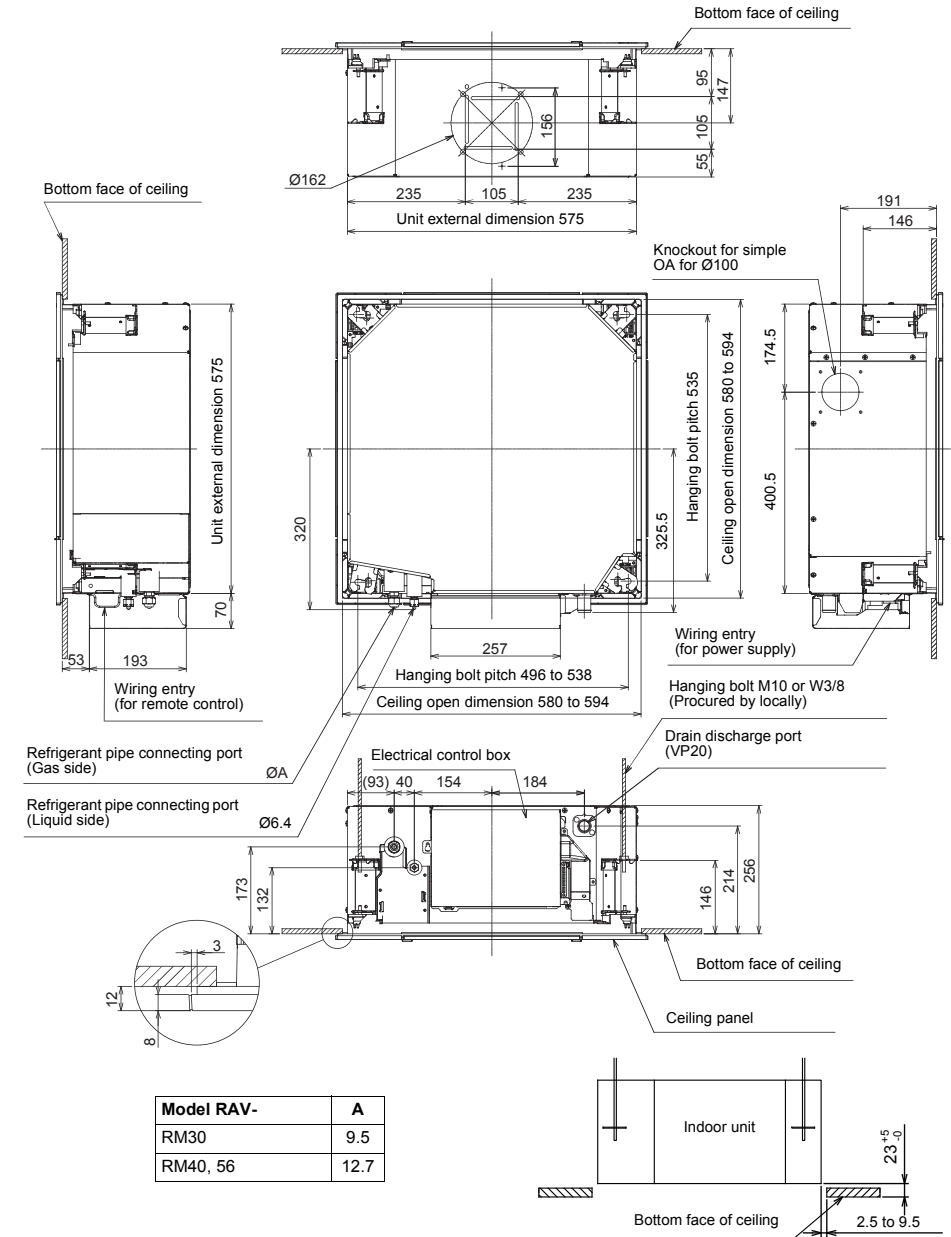

Model RAV-	A
RM30	9.5
RM40, 56	12.7

## ■ Opening a ceiling and installation of hanging bolts

- Consider the piping / wiring after the unit is hung to determine the location of the indoor unit installation and orientation.
- After the location of the indoor unit installation has been determined, open the ceiling and install hanging bolts.
- The dimensions of the ceiling opening and hanging bolt pitches are given in the outline drawing and the attached installation pattern.
- When a ceiling already exists, lay the drain pipe, refrigerant pipe, control wires, and remote controller wires to their connection locations before hanging the indoor unit.

Procure hanging bolts and nuts for installing the indoor unit (these are not supplied).

Hanging bolt	M10 or W3/8	4 pieces
Nut	M10 or W3/8	12 pieces

### Using the installation pattern (accessory)

The installation pattern is provided inside the packaging cap.

#### <For existing ceiling>

Use the installation pattern positioning a ceiling opening and hanging bolts.

#### <For new ceiling>

Use the installation pattern to position the ceiling opening when a ceiling is hanged.

- After the hanging bolts have been installed, install the indoor unit.
- After loosening the panel fixing screws of the indoor unit, hook them on the four holes in the installation pattern.
- When hanging a ceiling, open the ceiling along the outside dimensions of the installation pattern.

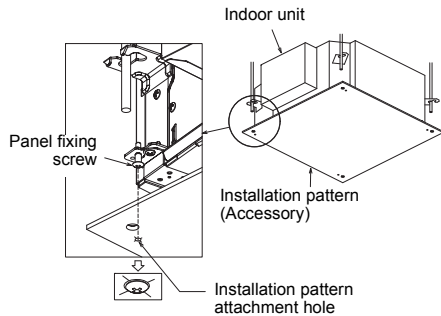

## Treatment of ceiling







The ceiling differs according to structure of building. For details, consult your constructor or interior finish contractor.

In the process after the ceiling board has been removed, it is important to reinforce ceiling foundation (frame) and to keep horizontal level of installed ceiling correctly in order to prevent vibration of ceiling board.

1. Cut and remove the ceiling foundation.
2. Reinforce the cut surface of ceiling foundation, and add ceiling foundation for fixing the end of ceiling board.

## Installation of hanging bolt

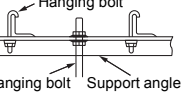
Use M10 hanging bolts (4 pcs, locally procured). Matching to the existing structure, set pitch according to size in the unit external view as shown below.

New concrete slab	
Install the bolts with insert brackets or anchor bolts.	
	
(Blade type bracket)	(Slide type bracket)
	
(Pipe hanging anchor bolt)	(Anchor bolt)
Steel frame structure	
Use existing angles or install new support angles.	
	
(Hanging bolt)	(Support angle)
Existing concrete slab	
Use a hole-in anchors, hole-in plugs, or a hole-in bolts.	
	
(Hole-in anchor)	(Hole-in plug)

## Installation of ceiling opening and hanging bolt

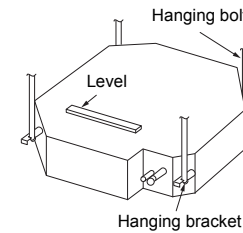

- Attach a nut (locally procured) and the washer (supplied) to each hanging bolt.
- Insert a washer on both sides of the T groove of the hanging bracket of the indoor unit, and hang the indoor unit.
- Check that the four sides of the indoor unit are level using a level gauge (levelness: 5 mm or less).
- Detach the installation gauge (accessory) from the installation pattern.
- Using the installation gauge, check and adjust the positional relation between the indoor unit and the ceiling opening (1) (2.5 - 9.5 mm: 4 sides) and the hanging-up height (2) (23 - 28 mm: 4 corners). (How to use the installation gauge is printed on the gauge.)

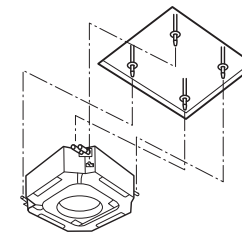
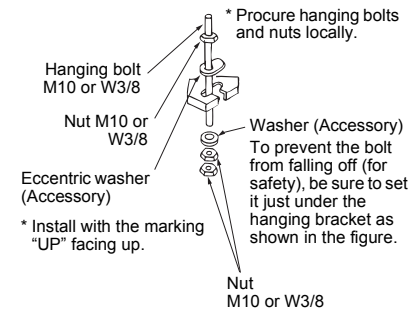

For the grid ceiling, incline the unit and then mount the unit from the electrical control box side as shown in the figure below.

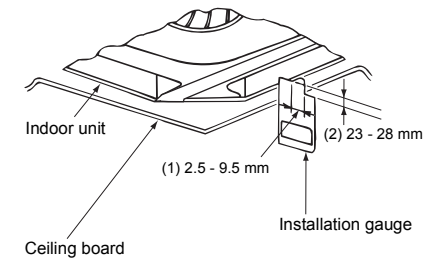
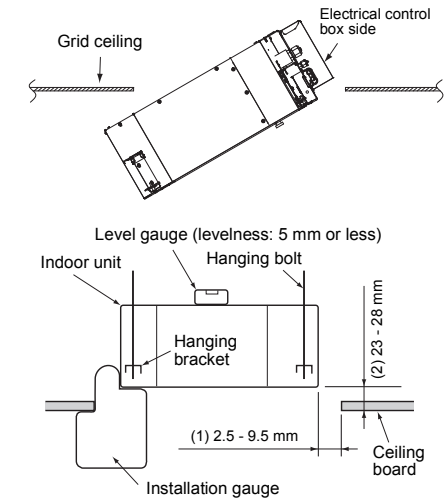

## CAUTION

Before installation of the indoor unit, remove the tape that holds the fan and bell mouth. Running the unit without removing the tape may damage the fan motor.

## ■ Installation of ceiling panel (Sold separately)

Install the ceiling panel according to Installation Manual attached with it after piping / wiring work has completed.

Check that installation of indoor unit and ceiling opening part is correct, and then install it.

### REQUIREMENT

- Joint the connecting sections of ceiling panel, ceiling surface, ceiling panel and indoor unit closely. Any gap between them will cause air leakage and the generate condensation or water leakage.
- Remove the adjust corner caps at the four corners of the ceiling panel, and then install the ceiling panel onto the indoor unit.  
Also, check that the claws are securely fit when returning the adjust corner caps to its original position.

## ■ Installation of remote controller (Sold separately)

For installation of the wired remote controller, follow the Installation Manual attached with the remote controller.

- Pull out the remote controller cord together with the refrigerant pipe or drain pipe.  
Pass the remote controller cord through upper side of the refrigerant pipe and drain pipe.
- Do not leave the remote controller at a place exposed to the direct sunlight and near a stove.

## ■ Wireless remote controller

The sensor of indoor unit with wireless remote controller can receive a signal by distance within approx. 7 m. Based upon it, determine a place where the remote controller is operated and the installation place.

- Operate the remote controller, confirm that the indoor unit receives a signal surely, and then install it.
- Keep 1 m or more from the devices such as television, stereo.  
(Disturbance of image or noise may generate.)
- To prevent a malfunction, select a place where is not influenced by a fluorescent light or direct sunlight.
- Two or more (Up to 6 units) indoor units with wireless type remote controller can be installed in the same room.

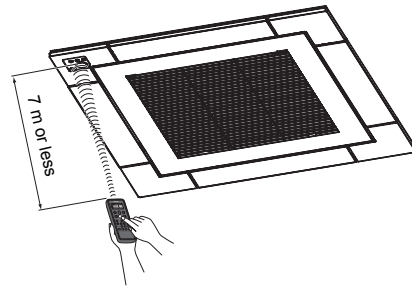

# 5 Drain piping

### CAUTION

Following the Installation Manual, perform the drain piping work so that water is properly drained, and apply a heat insulation so as not to cause a dew drop.  
Inappropriate piping work may result in water leakage in the room and wet of furniture.

## ■ Piping / Heat insulating material

Require the following materials for piping and heat insulating at site.

Piping	Hard vinyl chloride pipe VP20 (Outer dia.: Ø26 mm)
Heat insulator	Foam polyethylene: Thickness 10 mm or more

## ■ Flexible hose

Use the attached flexible hose to adjust centre discrepancy of the hard vinyl chloride pipe.

- Do not use the flexible hose as stretched, or do not deform.
- Fix the soft end of the flexible hose with the attached hose band.
- Use the flexible hose on a horizontal level.

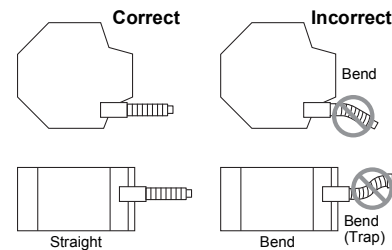

### REQUIREMENT

- Perform heat insulation of the drain pipes of the indoor unit.
- Perform heat insulation of the connecting part with the indoor unit.  
An incomplete heat insulation causes dew drop.
- Set the drain pipe with downward slope (1/100 or more), and do not make swelling or trap on the piping. It may cause an abnormal sound.
- For length of the traversing drain pipe, restrict to 20 m or less.  
In case of a long pipe, provide support brackets with interval of 1.5 - 2 m in order to prevent waving.

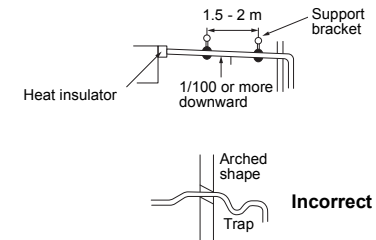

- Set the collective piping as shown in the below figure.

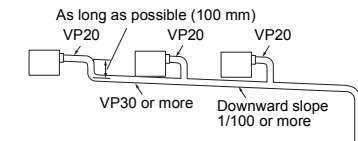

- Do not apply force to the connecting part of the drain pipe.
- The hard vinyl-chloride pipe cannot be directly connected to the drain pipe connecting port of the indoor unit.  
For connection with the drain pipe connecting port, fix the attached flexible hose with the hose band, otherwise a damage or water leak is caused on the drain pipe connecting port.

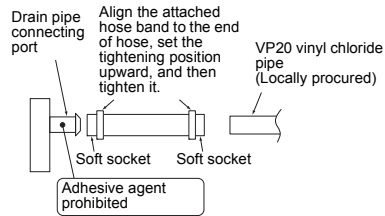

- Adhesive agent cannot be used for the pipe connecting port (Soft socket) of the indoor unit. Be sure to use the attached hose band for fixing, otherwise damage or water leakage of the drain pipe connecting port is caused.

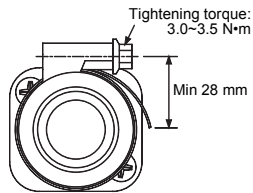
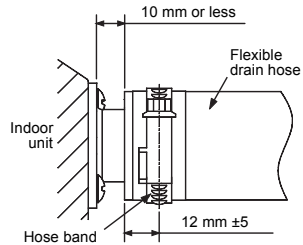

## ■ Connecting drain pipe

- Connect VP20 hard vinyl chloride pipe (Locally procured) to flexible drain hose using attached hose band.

## ■ Drain up

When a down-gradient cannot be secured for the drainpipe, drain-up piping is possible.

- The height of the drain pipe must be 850 mm or less from the bottom of the ceiling.
- Take the drain pipe out of the drain pipe joint with the indoor unit in 300 mm or less, and bend up the pipe vertically.
- Immediately after the pipe is bent up vertically, lay the pipe making a down-gradient.
- Set downward grading immediately after raising up vertically.

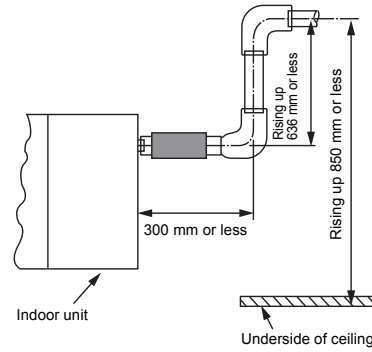

## ■ Check the draining

In the test run, check that water drain is properly performed and water does not leak from the connecting part of the pipes.

Check draining also when installed in heating period. By using a pitcher or hose, pour water (1500 - 2000 cc) into the discharge port before installation of the ceiling panel.

Pour water gradually so that water does not spread on the motor of the drain pump.

### ⚠ CAUTION

Pour water gently so that it does not spread around inside the indoor unit, which may cause a malfunction.

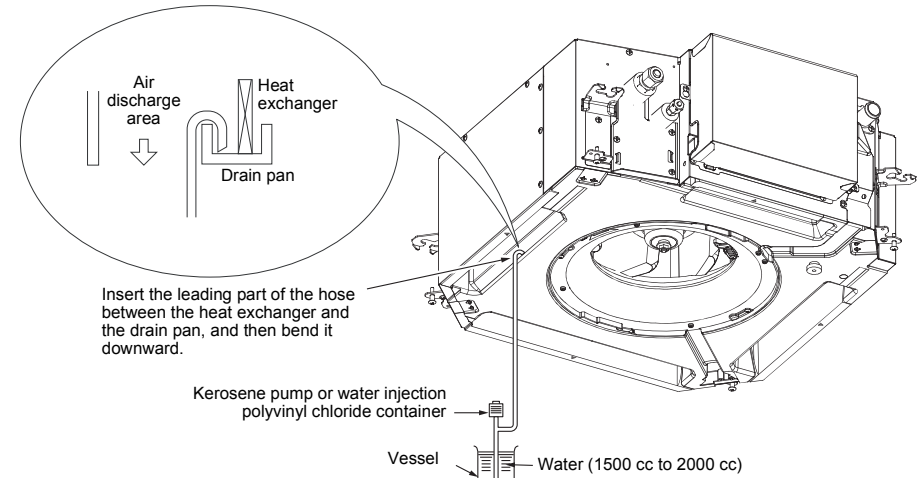

- After the electric work has finished, pour water during COOL mode operation.
- If the electric work has not yet finished, pull out the float switch connector (CN34: Red) from the electrical control box, and check draining by plugging the single phase 220 - 240 V power to the terminal blocks ① and ②. If doing so, the drain pump motor operates. (Never apply 220-240 V to ① or ②, otherwise a trouble of P.C. board occurs.)
- Test water drain while checking the operation sound of the drain pump motor. (If the operation sound changes from continuous sound to intermittent sound, water is normally drained.) After the check, the drain pump motor runs, connecting the float switch connector. (In case of check by pulling out the float switch connector, be sure to return the connector to the original position.)

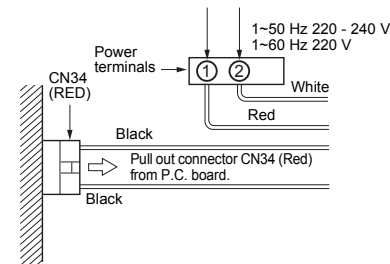

## ■ Perform heat insulating

- As shown in the figure, cover the flexible hose and hose band with the attached heat insulator up to the bottom of the indoor unit without gap.
- Cover the drain pipe seamlessly with a heat insulator to be procured locally so that it overlaps with the attached heat insulator of the drain connecting section.

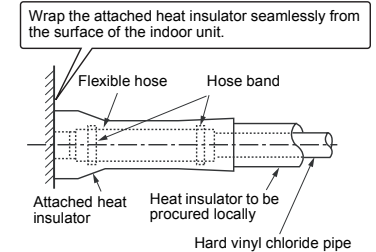

- \* Direct the slits and seams of the heat insulator upward to avoid water leakage.

# 6 Refrigerant piping

## CAUTION

Use flare nuts that are included with the unit. Using different flare nuts may cause refrigerant gas leakage.

## Refrigerant piping

Use the following item for the refrigerant piping.

**Material : Seamless phosphorous deoxidized copper pipe.**  
**Ø6.35, Ø9.52, Ø12.7 Wall thickness 0.8 mm or more**

### REQUIREMENT

When the refrigerant pipe is long, provide support brackets at intervals of 2.5 - 3 m to clamp the refrigerant pipe. Otherwise, abnormal sound may be generated.

## CAUTION

### IMPORTANT 4 POINTS FOR PIPING WORK

1. Reusable mechanical connectors and flared joints are not allowed indoors. When mechanical connectors are reused indoors, sealing parts shall be renewed. When flared joints are reused indoors, the flare part shall be refabricated.
2. Tight connection (between pipes and unit)
3. Evacuate the air in the connecting pipes by using VACUUM PUMP.
4. Check the gas leakage. (Connected points)

## Pipe size

Model name	RAV-	RM30 type	RM40, 56 type
Pipe size	Gas side	9.5 mm	12.7 mm
	Liquid side	6.4 mm	6.4 mm

## Permissible piping length and height difference

They vary according to the outdoor unit.  
 For details, refer to the Installation Manual attached to the outdoor unit.

### Flaring

- Cut the pipe with a pipe cutter. Remove burrs completely. Remaining burrs may cause gas leakage.
- Insert a flare nut into the pipe, and flare the pipe. As the flaring sizes of R32 or R410A differ from those of refrigerant R22, the flare tools newly manufactured for R32 or R410A are recommended. However, the conventional tools can be used by adjusting projection margin of the copper pipe.

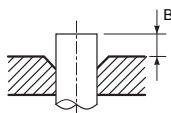

### Projection margin in flaring: B (Unit: mm)

Rigid (Clutch type)

Outer dia. of copper pipe	R32 or R410A tool used	Conventional tool used
6.4, 9.5	0 - 0.5	1.0 - 1.5
12.7		

### Flaring dia. meter size: A (Unit: mm)

Outer dia. of copper pipe	A <sup>+0 -0.4</sup>
6.4	9.1
9.5	13.2
12.7	16.6

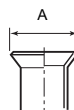

## CAUTION

- Do not scratch the inner surface of the flared part when removing burrs.
- Flare processing under the condition of scratches on the inner surface of flare processing part will cause refrigerant gas leak.
- Check that the flared part is not scratched, deformed, stepped, or flattened, and that there are no chips adhered or other problems, after flare processing.
- Do not apply refrigerating machine oil to the flare surface.

## Tightening connection

## CAUTION

Do not apply excessive torque. Otherwise, the nut may crack depending on the conditions.

Unit: N•m

Outer dia. of copper pipe	Tightening torque
6.4 mm	14 - 18
9.5 mm	34 - 42
12.7 mm	49 - 61

### Tightening torque of flare pipe connections

Incorrect connections may cause not only a gas leak, but also a trouble of the refrigeration cycle.

Align the centres of the connecting pipes and tighten the flare nut as far as possible with your fingers. Then tighten the nut with a spanner and torque wrench as shown in the figure.

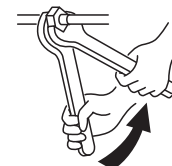

Work using two spanner

### REQUIREMENT

Tightening with an excessive torque may crack the nut depending on installation conditions.  
 Tighten the nut within the specified tightening torque.

## Evacuation

Perform vacuuming from the charge port of valve of the outdoor unit by using a vacuum pump.

For details, follow to the Installation Manual attached to the outdoor unit.

- Do not use the refrigerant sealed in the outdoor unit for evacuation.

### REQUIREMENT

For the tools such as charge hose, use those manufactured exclusively for R32 or R410A.

### Refrigerant amount to be added

For addition of the refrigerant, add refrigerant "R32 or R410A" referring to the attached Installation Manual of outdoor unit.

Use a scale to charge the refrigerant of specified amount.

### REQUIREMENT

- Charging an excessive or too little amount of refrigerant causes a trouble of the compressor. Charge the refrigerant of specified amount.
- A personnel who charged the refrigerant should write down the pipe length and the added refrigerant amount in the F-GAS label of the outdoor unit. It is necessary to fix the compressor and refrigeration cycle malfunction.

### Open the valve fully

Open the valve of the outdoor unit fully. A 4 mm-hexagonal wrench is required for opening the valve. For details, refer to the Installation Manual attached to the outdoor unit.

### Gas leak check

Check with a leak detector or soap water whether gas leaks or not, from the pipe connecting section or cap of the valve.

### REQUIREMENT

Use a leak detector manufactured exclusively for HFC refrigerant (R32, R410A, R134a).

### Heat insulation process

Apply heat insulation for the pipes separately at liquid side and gas side.

- For the heat insulation to the pipes at gas side, use the material with heat-resisting temperature 120 °C or higher.
- Apply the attached heat insulation to the pipe connecting section of the indoor unit securely without gap.

#### REQUIREMENT

- Apply the heat insulation to the pipe connecting section of the indoor unit securely up to the root without exposure of the pipe. (The pipe exposed to the outside causes water leak.)
- Wrap heat insulator with its slits facing up (ceiling side).

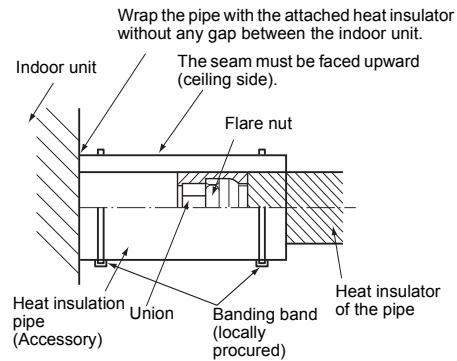

## 7 Electrical connection

### ⚠ WARNING

- **Use the specified wires for wiring connect the terminals. Securely fix them to prevent external forces applied to the terminals from affecting the terminals.**  
Incomplete connection or fixation may cause a fire or other trouble.
- **Connect earth wire. (grounding work)**  
Incomplete earthing cause an electric shock.  
Do not connect earth wires to gas pipes, water pipes, lightning conductor or telephone earth wires.
- **Appliance shall be installed in accordance with national wiring regulations.**  
Capacity shortage of power circuit or incomplete installation may cause an electric shock or a fire.
- **Under no circumstances, the power supply wire or the indoor and outdoor connecting wire must not be connected in the middle (Connection using a solderless terminal etc.)**  
Connection trouble in the places where the wire is connected in the middle may give rise to smoking and/or a fire.

### ⚠ CAUTION

- For power supply specifications, follow the Installation Manual of outdoor unit.
  - Do not connect 220 – 240 V power to the terminal blocks (Ⓐ, Ⓑ) for control wiring. Otherwise, the system will fail.
  - Do not damage or scratch the conductive core and inner insulator of power and system interconnection wires during peeling them.
  - Perform the electric wiring so that it does not come to contact with the high-temperature part of the pipe. The coating may melt resulting in an accident.
- 
- Do not turn on the power of the indoor unit until vacuuming of the refrigerant pipes completes.

## ■ Wiring connection

### Indoor / Outdoor connecting wires specifications

#### Indoor unit power supplied from outdoor unit

- The outdoor unit power supply patterns vary on models.

Indoor unit power supply	1~50 Hz 220 - 240 V 1~60 Hz 220 V	
Indoor / Outdoor connecting wires*	4 × 1.5 mm <sup>2</sup> or more (H07 RN-F or 60245 IEC 66)*	Up to 70 m

\*Number of wire × wire size  
\*Including earth line

### Remote controller wiring

Remote controller wiring, remote controller inter-unit wiring	Wire size: 2 × 0.5 to 2.0 mm <sup>2</sup>	
Total wire length of remote controller wiring and remote controller inter-unit wiring = L + L1 + L2 + ... Ln	In case of wired type only	Up to 500 m
	In case of wireless type included	Up to 400 m *1
Total wire length of remote controller inter-unit wiring = L1 + L2 + ... Ln		Up to 200 m

\* 1 For detail of the wired remote controller (RBC-AMS55E\*), follow the Installation Manual attached with the remote controller.

### ⚠ CAUTION

The remote controller wire and Indoor / Outdoor connecting wires cannot be parallel to contact each other and cannot be stored in the same conduits. If doing so, a trouble may be caused on the control system due to noise or other factor.

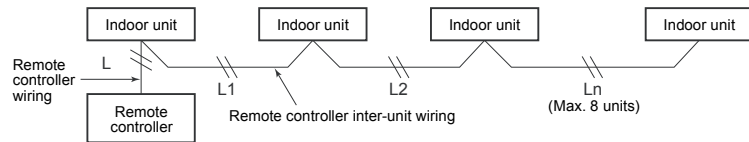

## ■ Wiring between indoor unit and outdoor unit

- Figure below shows the wiring connections between the indoor and outdoor units and between the indoor units and remote controller. The wires indicated by the broken lines or dot-and-dash lines are provided at the locally.
- Refer to the both indoor and outdoor unit wiring diagrams.
- The power of the indoor unit is supplied from the outdoor unit.

### Wiring diagram

#### Single system

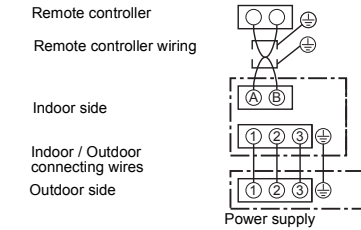

#### Simultaneous twin system

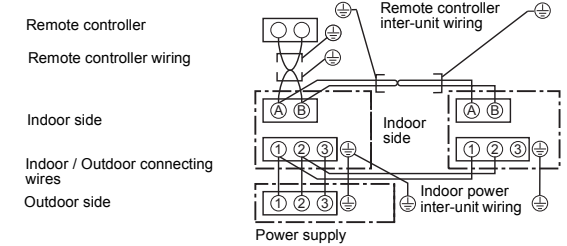

#### Simultaneous triple and double twin system

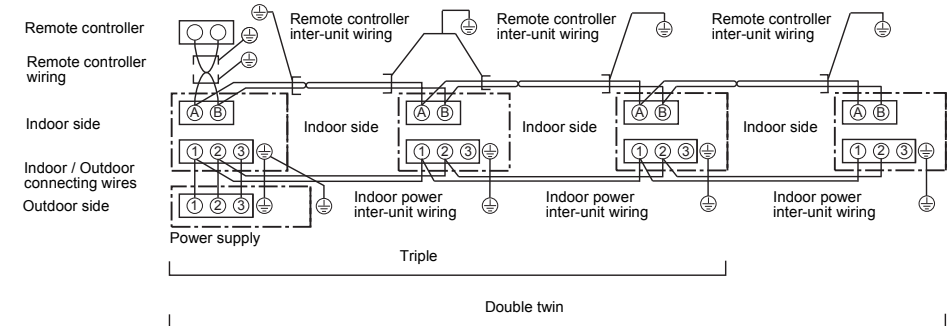

\* Use 2-core shield wire (MVVS 0.5 to 2.0 mm<sup>2</sup> or more) for the remote controller wiring in the simultaneous twin, simultaneous triple and simultaneous double twin systems to prevent noise problems. Connect both ends of the shield wire to earth leads.

\* Connect earth wires for each indoor unit in the simultaneous twin, simultaneous triple and simultaneous double twin systems.



## ■ Wire connection

### REQUIREMENT

- Connect the wires matching the terminal numbers. Incorrect connection causes a trouble.
- Route the wire through the wire connection port of the indoor unit.
- The low-voltage circuit is provided for the control wire and remote controller wire. (Do not connect the high-voltage circuit.)

1. Loosen the two screws, and remove the cover of electrical control box by sliding in the direction of the arrow.
2. Connect the Indoor / Outdoor connecting wires and remote controller wire to the terminal block of the electrical control box.
3. Tighten the screws of the terminal block, and fix the wires with cord clamp attached to the electrical control box. (Do not apply tension to the connecting section of the terminal block.)
4. Mount the cover of the electrical control box without pinching wires. (Mount the cover after wiring on the ceiling panel.)

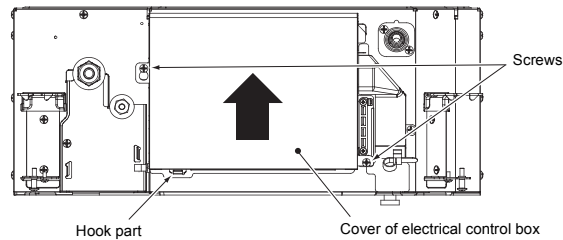

Select side C or D for the cord clamp position referring to the following table according to the cable type and diameter.  
 \* Cord clamp can be attached on either right or left side.  
 When twin system are connected, clamp two cables with one cord clamp.

Wire type	Specification	Cord clamping position
Cabtyre cable	3-core stranded wire 2.5 mm <sup>2</sup>	Side D
Cabtyre cable	4-core stranded wire 1.5 mm <sup>2</sup>	Side C

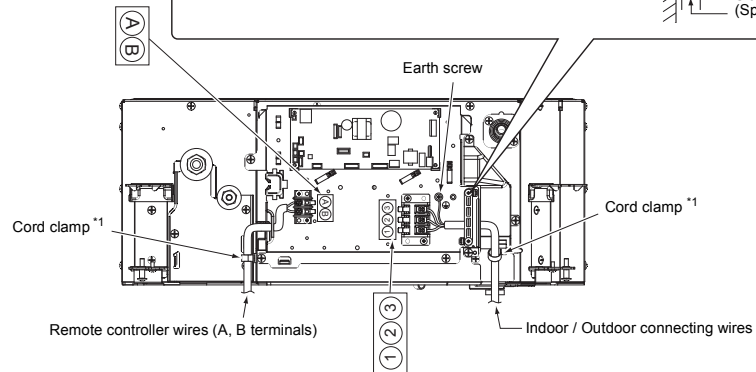
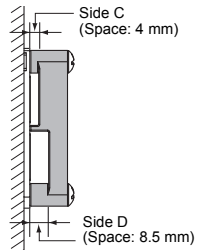

## ⚠ CAUTION

- \*1 Make sure to fix the power supply wire with the cord clamp so that no water enters into the electrical control box through the power supply wire.

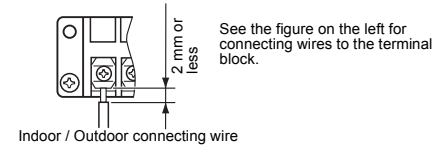
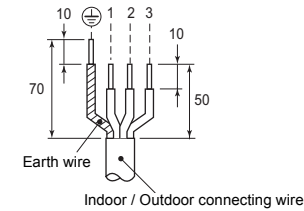
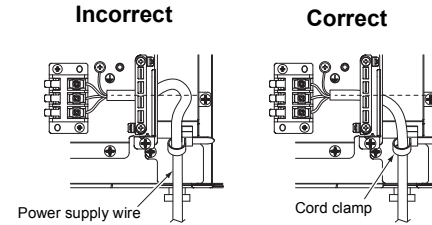

## ■ Wiring on the ceiling panel

According to the Installation Manual of the ceiling panel, connect the louver motor connector on the ceiling panel side and the louver motor connector on the indoor unit side.

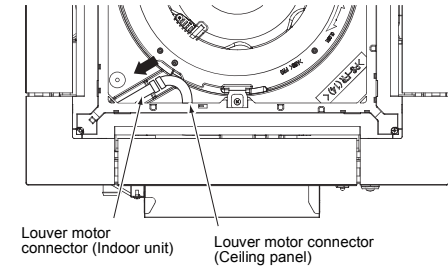

## ■ Remote controller wiring

Strip off approx. 9 mm the wire to be connected.

### Wiring diagram

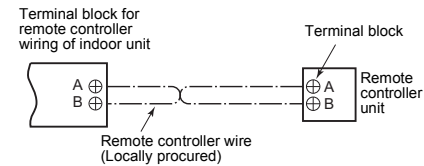

# 8 Applicable controls

- For using the wired remote controller RBC-AMS55E\*, refer to the Owner's Manual attached to the wired remote controller.

### REQUIREMENT

- When you use this air conditioner for the first time, it takes approx. 5 minutes until the remote controller becomes available after power-on. This is normal. **<When power is turned on for the first time after installation>** It takes **approx. 5 minutes** until the remote controller becomes available.

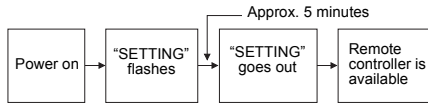

**<When power is turned on for the second (or later) time>**

- It takes **approx. 1 minute** until the remote controller becomes available.

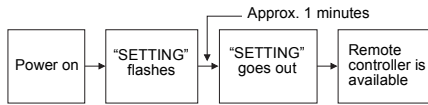

- Normal settings were made when the indoor unit was shipped from factory. Change the indoor unit settings as required.
- Use the wired remote controller to change the settings.
  - \* The settings cannot be changed using the wireless remote controller, sub remote controller, or remote-controller-less system (for central remote controller only). Therefore, install the wired remote controller to change the settings.

## Basic procedure for changing settings

Change the settings while the air conditioner is not working. **(Stop the air conditioner before making settings.)**

### CAUTION

Set only the CODE No. shown in the following table: Do NOT set any other CODE No. If a CODE No. not listed is set, it may not be possible to operate the air conditioner or other trouble with the product may result.

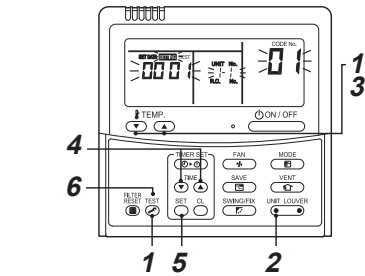

- Push and hold **TEST** button and **"TEMP."** button simultaneously for at least 4 seconds. After a while, the display flashes as shown in the figure. Confirm that the CODE No. is [01].
  - If the CODE No. is not [01], push **TEST** button to clear the display content, and repeat the procedure from the beginning. (No operation of the remote controller is accepted for a while after button is pushed.) (While air conditioners are operated under the group control, "ALL" is displayed first. When **UNIT LOUVER** is pushed, the indoor unit number displayed following "ALL" is the header unit.)

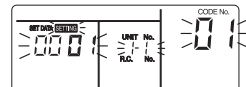

(\* Display content varies with the indoor unit model.)

- Each time **UNIT LOUVER** button is pushed, indoor unit numbers in the control group change cyclically. Select the indoor unit to change settings for.

The fan of the selected unit runs and the louvers start swinging. The indoor unit for change settings can be confirmed.

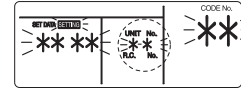

- Specify CODE No. [\*\*] with **"TEMP."** button.

- Select SET DATA [\*\*\*\*] with **"TIME"** button.

- Push **SET** button. When the display changes from flashing to lit, the setup is completed.

- To change settings of another indoor unit, repeat from Procedure 2.
- To change other settings of the selected indoor unit, repeat from Procedure 3.

Use **SET** button to clear the settings. To make settings after **SET** button was pushed, repeat from Procedure 2.

- When settings have been completed, push **TEST** button to determine the settings.

When **TEST** button is pushed, **SETTING** flashes and then the display content disappears and the air conditioner enters the normal stop mode.

(While **SETTING** is flashing, no operation of the remote controller is accepted.)

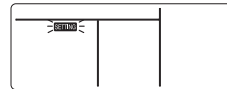

## Installing indoor unit on high ceiling

When an indoor unit is installed on a ceiling higher than the standard height, make the high-ceiling setting for fan speed adjustment.

Follow to the basic operation procedure

(1 → 2 → 3 → 4 → 5 → 6).

- For the CODE No. in Procedure 3, specify [5d].
- Select the SET DATA for Procedure 4 from the "Height list of ceiling possible to be installed" table in this manual.

### Remote controller-less setting

Change the high-ceiling setting with the DIP switch on the receiver section P.C. board.

For details, refer to the manual of the wireless remote controller kit. The settings can also be changed with the switch on the indoor microcomputer P.C. board.

- \* Once the setting is changed, setting to 0001 or 0003 is possible, however setting to 0000 requires a setting data change to 0000 using the wired remote controller (separately sold) with the normal switch setting (factory default).

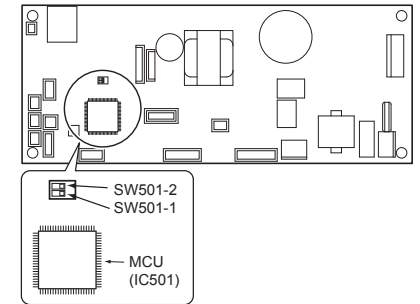

SET DATA	SW501-1	SW501-2
<b>0000</b> (Factory default)	OFF	OFF
<b>0001</b>	ON	OFF
<b>0003</b>	OFF	ON

### To restore the factory defaults

To return the DIP switch settings to the factory defaults, set SW501-1 and SW501-2 to OFF, connect a separately sold wired remote controller, and then set the data of CODE No. [5d] to "0000".

## Filter sign setting

According to the installation condition, the filter sign term (Notification of filter cleaning) can be changed. Follow to the basic operation procedure (1 → 2 → 3 → 4 → 5 → 6).

- For the CODE No. in Procedure 3, specify [01].
- For the [SET DATA] in Procedure 4, select the SET DATA of filter sign term from the following table.

SET DATA	Filter sign term
0000	None
0001	150 H
0002	2500 H (Factory default)
0003	5000 H
0004	10000 H

## To secure better effect of heating

When it is difficult to obtain satisfactory heating due to installation place of the indoor unit or structure of the room, the detection temperature of heating can be raised. Also use a circulator or other device to circulate heat air near the ceiling.

Follow to the basic operation procedure (1 → 2 → 3 → 4 → 5 → 6).

- For the CODE No. in Procedure 3, specify [06].
- For the set data in Procedure 4, select the SET DATA of shift value of detection temperature to be set up from the following table.

SET DATA	Detection temperature shift value
0000	No shift
0001	+1 °C
0002	+2 °C (Factory default)
0003	+3 °C
0004	+4 °C
0005	+5 °C
0006	+6 °C

## How to set up swing type

- Push for at least four seconds when the air conditioner is not working. Indicates CODE No. [F0].
- Select an indoor unit to be set by pushing (left side of the button). Each time you push the button, unit numbers change as follows:

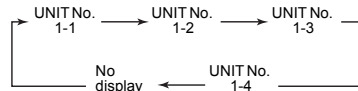

The fan of the selected unit runs and the louvers start swinging.

- Select a swing type by pushing "TIME" buttons.

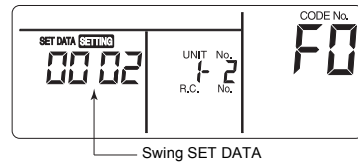

Swing SET DATA	Swing of louvers
0001	Standard swing (Factory default)
0002	Dual swing
0003	Cycle swing

### CAUTION

Do not set the swing SET DATA to "0000".  
(This setting may cause a failure of the louvers.)

- About "Dual swing"**  
"Dual" means that louvers 01 and 03 are directed and swing in one direction and louvers 02 and 04 are directed and swing in the opposite direction. (When louvers 01 and 03 are directed downward, louvers 02 and 04 are directed horizontally.)
- About "Cycle swing"**  
The four louvers swing independently at respective timings.

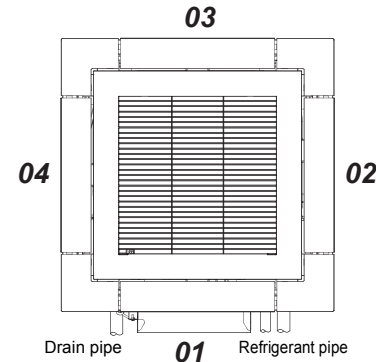

- Push .
- Push to complete the setting.

## How to set up louver lock (No swing)

- Push (right side of the button) for at least four seconds when the air conditioner is not working. Indicates CODE No. [F1].
- Select an indoor unit to be set by pushing (left side of the button). Each time you push the button, unit numbers change as follows:  
The fan of the selected unit runs and the louvers start swinging.

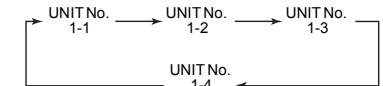

- Select a louver you want to lock by pushing "TEMP." buttons.
- Select the wind direction of the louver you do not want to swing by pushing "TIME" buttons.

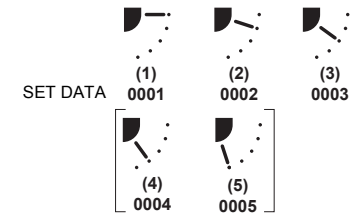

- \* When (4) or (5) is selected, dew drop may occur during cooling mode.
- Determine the setting by pushing button. When the setting has been determined, lights up.
  - Push to complete the setting.

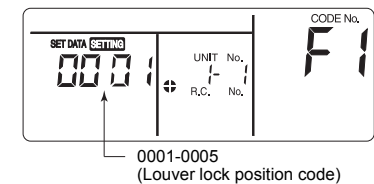

## How to cancel louver lock

Set the wind direction to "0000" of the louver lock setup procedure above.



Setting data 0000

- When the setting is canceled, goes out. Other operations are the same as those in "How to set up louver lock (No swing)".

## Remote controller sensor

The temperature sensor of the indoor unit senses room temperature usually. Set the remote controller sensor to sense the temperature around the remote controller. Select items following the basic operation procedure (1 → 2 → 3 → 4 → 5 → 6).

- Specify [32] for the CODE No. in Procedure 3.
- Select the following data for the SET DATA in Procedure 4.

SET DATA	0000	0001
Remote controller sensor	Not used (factory default)	Used

When flashes, the remote controller sensor is defective.

Select the SET DATA [0000] (not used) or replace the remote controller.

## Power saving mode

### Performing settings of the power saving mode

- Push button for 4 seconds or more when the air conditioner is not working. flashes. Indicates CODE No. [C2.]

- Select an indoor unit to be set by pushing (left side of the button).

Each time the button is pushed, unit numbers change as follows:

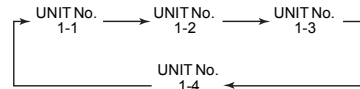

The fan of the selected unit runs.

- Adjust the power save setting by pushing TIME buttons.

Each push of the button changes the power level by 1% within the range from 100% to 50%.  
\*The factory default is 75%.

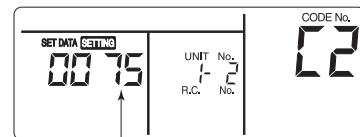

Setting of power level in power saving mode

- Determine the setting by pushing .
- Push to complete the setting.

## Remote controller switch monitoring function

This function is available to call the service monitor mode from the remote controller during a test run to acquire temperatures of sensors of the remote controller, indoor unit, and outdoor unit.

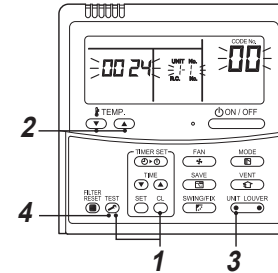

- Push and buttons simultaneously for at least 4 seconds to call the service monitor mode.

The service monitor indicator lights up and the header indoor unit number is displayed first. CODE No. is also displayed.

- Pushing TEMP. buttons, select the number of sensor (CODE No.) to be monitored. (See the following table.)

- Pushing (left side of the button), select an indoor unit to be monitored. The sensor temperatures of indoor units and their outdoor unit in the control group are displayed.

- Push button to return to the normal display.

Indoor unit data	
CODE No.	Data name
01	Room temperature (remote controller)
02	Indoor unit intake air temperature (TA)
03	Indoor unit heat exchanger (coil) temperature (TCJ)
04	Indoor unit heat exchanger (coil) temperature (TC)
F3	Indoor unit fan cumulative operating hours (x1 h)

Outdoor unit data	
CODE No.	Data name
60	Outdoor unit heat exchanger (coil) temperature (TE)
61	Outside air temperature (TO)
62	Compressor discharge temperature (TD)
63	Compressor suction temperature (TS)
65	Heatsink temperature (THS)
6A	Operating current (x1/10)
6D	Outdoor heat exchange (coil) temperature (TL)
F1	Compressor cumulative operating hours (x100 h)

## ■ Group control

### Simultaneous twin, triple or double twin system

A combination with an outdoor unit allows simultaneous ON / OFF operation of the indoor units. The following system patterns are available.

- Two indoor units for the twin system
- Three indoor units for the triple system
- Four indoor units for the double-twin system

#### ▼ Twin system

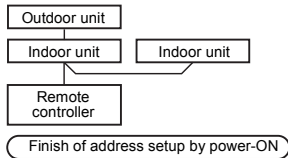

#### ▼ Triple system

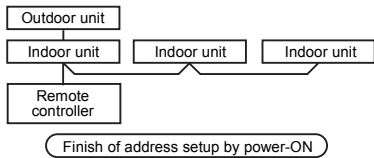

#### ▼ Double twin

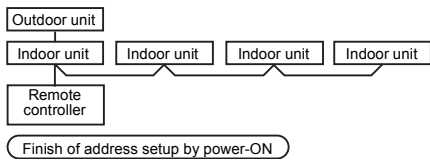

- For wiring procedure and wiring method, follow to the "Electrical connection" in this manual.
- When the power supply has been turned on, the automatic address setup starts and which indicates that address is being set up flashes on the display part.

During setup of automatic address, the remote controller operation is not accepted.

**Required time up to the finish of automatic addressing is approx. 5 minutes.**

### Group control for system of multiple units

One remote controller can control maximum 8 indoor units as a group.

#### ▼ Group control in single system

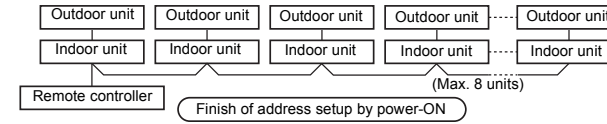

- For wiring procedure and wiring method of the individual line (Identical refrigerant line) system, follow to "Electrical connection".
- Wiring between lines is performed in the following procedure. Connect the terminal block (A/B) of the indoor unit connected with a remote controller to the terminal blocks (A/B) of the indoor units of other indoor units by wiring the inter-unit wire of the remote controller.
- When the power supply has been turned on, the automatic address setup starts and which indicates that address is being set up flashes on the display part in about 3 minutes. During setup of automatic address, the remote controller operation is not accepted.

**Required time up to the finish of automatic addressing is approx. 5 minutes.**

#### NOTE

In some cases, it is necessary to change the address manually after setup of the automatic address according to the system configuration of the group control.

- The follow mentioned system configuration is a case when complex systems in which systems of the simultaneous twin and simultaneous triple unit is controlled as a group by a remote controller.

### (Example) Group control for complex system

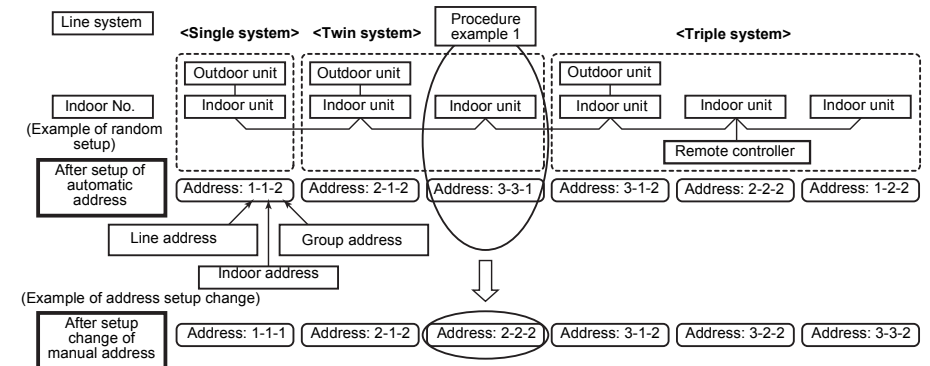

**The above address is set by the automatic addressing when the power is turned on. However, line addresses and indoor addresses are set randomly. For this reason, change the setting to match line addresses with indoor addresses.**

**[Procedure example]**

**Manual address setup procedure**

While the operation stops, change the setup.  
(Stop the operation of the unit.)

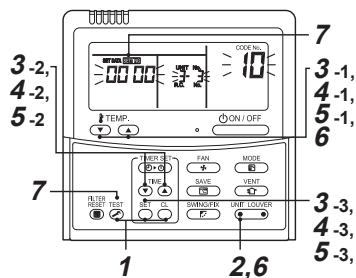

**1** Push **SET + CL + TEST** buttons simultaneously for 4 seconds or more. After a while, the display part flashes as shown below. Check the displayed CODE No. is [10].

- When the CODE No. is other than [10], push **TEST** button to erase the display and repeat procedure from the first step.  
(After pushing **TEST** button, operation of the remote controller is not accepted for approx. 1 minute.)  
(For a group control, No. of the firstly displayed indoor unit becomes the header unit.)

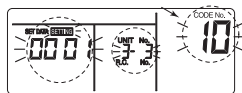

(\* Display changes according to the model No. of indoor unit.)

**2** Every time **UNIT LOUVER** button is pushed, the indoor UNIT No. in the group control is displayed in order. Select the indoor unit of which setup is changed.

In this time, the position of the indoor unit of which setup is changed can be confirmed because fan of the selected indoor unit operate.

**3**

- Specify CODE No. [12] with TEMP.  $\downarrow$  /  $\uparrow$  buttons.  
(CODE No. [12]: Line address)
- Change the line address from [3] to [2] with TIME  $\downarrow$  /  $\uparrow$  buttons.
- Push **SET** button.

In this time, the setup finishes when the display changes from flashing to lighting.

Indoor UNIT No. before setup change is displayed.

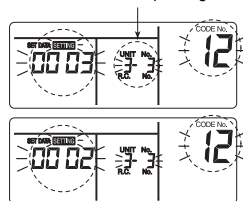

**4**

- Specify CODE No. [13] with TEMP.  $\downarrow$  /  $\uparrow$  buttons.  
(CODE No. [13]: Indoor address)
- Change the indoor address from [3] to [2] TIME  $\downarrow$  /  $\uparrow$  buttons.
- Push **SET** button.

In this time, the setup finishes when the display changes from flashing to lighting.

Indoor UNIT No. before setup change is displayed.

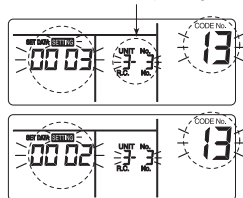

**5**

- Specify CODE No. [14] TEMP.  $\downarrow$  /  $\uparrow$  buttons.  
(CODE No. [14]: Group address)
- Change the SET DATA from [0001] to [0002] TIME  $\downarrow$  /  $\uparrow$  buttons.  
(SET DATA [Header unit: 0001] [Follower unit: 0002])
- Push **SET** button.

In this time, the setup finishes when the display changes from flashing to lighting.

Indoor UNIT No. before setup change is displayed.

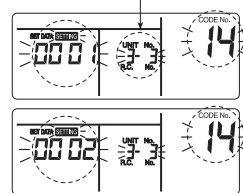

**6** If there is other indoor unit to be changed, repeat procedure 2 to 5 to change the setup.

When the above setup has finished, push **UNIT LOUVER** to select the indoor UNIT No. before change of setup, specify CODE No. [12], [13], [14] in order with TEMP.  $\downarrow$  /  $\uparrow$  buttons, and then check the changed contents.

Address change check Before change: [3-3-1] → After change: [2-2-2]

Pushing **SET** button clears the contents of which setup was changed.  
(In this case, procedure from 2 is repeated.)

Indoor UNIT No. before setup change is displayed.

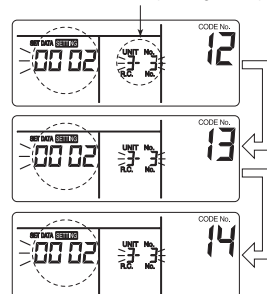

**7**

After check of the changed contents, push **TEST** button. (Setup is determined.) When **TEST** button is pushed, the display disappears and the status becomes the usual stop status. (When **TEST** button is pushed the operation from the remote controller is not accepted for approx. 1 minute.)

- If the operation from the remote controller is not accepted even 1 minute or more passed after pushing **TEST** button, it is considered that the address setup is incorrect.

In this case, the automatic address must be again set up.  
Therefore repeat procedure of the setup change from the Procedure 1.

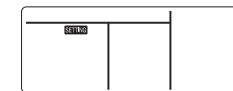

**To recognize the position of the corresponding indoor unit through the indoor UNIT No. is known**

Check the position during operation stop.  
(Stop operation of the set.)

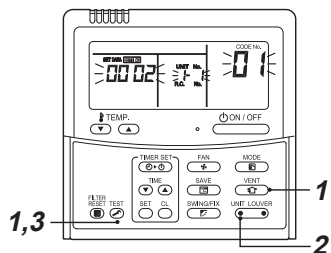

**1 Push TEST + VENT buttons simultaneously for 4 seconds or more.**

After a while, the display part flashes and the display appears as shown below.  
In this time, the position can be checked because fan of the indoor unit operate.

- For the group control, the indoor UNIT No. is displayed as [ALL] and fans of all the indoor units in the group control operate. Check the displayed CODE No. is [01].
- When the CODE No. is other than [01], push TEST button to erase the display and repeat procedure from the first step.  
(After pushing TEST button, operation of the remote controller is not accepted for approx. 1 minute.)

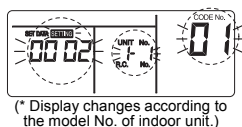

(\* Display changes according to the model No. of indoor unit.)

**2 In the group control, every time UNIT LOUVER button is pushed, the indoor UNIT No. in the group control is displayed in order.**

In this time, the position of the indoor unit can be confirmed because only fan of the selected indoor unit operate.

(For a group control, No. of the firstly displayed indoor unit becomes the header unit.)

**3 After confirmation, push TEST button to return the mode to the usual mode.**

When TEST button is pushed, the display disappears and the status becomes the usual stop status.

(When TEST button is pushed the operation from the remote controller is not accepted for approx. 1 minute.)

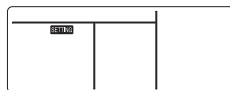

**8 °C operation**

Pre-heating operation can be set for cold regions where room temperature drops to below zero.

**1 Push SET + CL + TEST buttons simultaneously for 4 seconds or more when the air conditioner is not working.**

After a while, the display part flashes as shown below. Check the Displayed CODE No. is [10].

- When the CODE No. is other than [10], push TEST button to erase the display and repeat procedure from the first step.  
(After pushing TEST button, operation of the remote controller is not accepted for approx. 1 minute.)

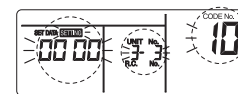

(\* Display changes according to the model No. of indoor unit.)

- 2 Every time UNIT LOUVER button is pushed, the indoor unit No. in the group control is displayed in order. Select the indoor unit of which setup is changed. In this time, the position of the indoor unit of which setup is changed can be confirmed because fan of the selected indoor unit operate.**

**3 Specify CODE No. [d1] TEMP. DOWN / UP buttons.**

**4 Select SET DATA [0001] TIME DOWN / UP buttons.**

SET DATA	8 °C Operation setting
0000	None (Factory default)
0001	8 °C Operation setting

**5 Push SET button. In this time, the setup finishes when the display changes from flashing to lighting.**

**6 Push TEST button.(Setup is determined.)**

When TEST button is pushed, the display disappears and the status becomes the usual stop status. (When TEST button is pushed the operation from the remote controller is not accepted for approx. 1 minute.)

# 9 Test run

## ■ Before test run

- Before turning on the power supply, carry out the following procedure.
  - 1) By using 500 V-megger, check that resistance of 1 MΩ or more exists between the terminal block 1 to 3 and the earth (grounding). If resistance of less than 1 MΩ is detected, do not run the unit.
  - 2) Check the valve of the outdoor unit being opened fully.
- To protect the compressor at activation time, leave power-ON for 12 hours or more before operating.

## ■ Execute a test run

Operate the unit with the wired remote controller as usual.

For the procedure of the operation, refer to the attached Owner's Manual.

A forced test run can be executed in the following procedure even if the operation stops by thermostat-OFF.

In order to prevent a serial operation, the forced test run is released after 60 minutes have passed and returns to the usual operation.

### ⚠ CAUTION

Do not use the forced test run for cases other than the test run because it applies an excessive load to the devices.

## Wired remote controller

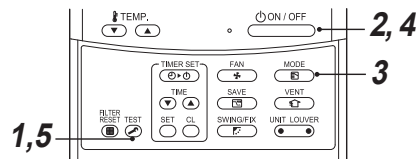

- 1 Push **TEST** button for 4 seconds or more. [TEST] is displayed on the display part and the selection of mode in the test mode is permitted.

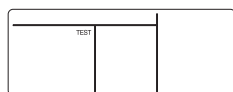

- 2 Push **ON/OFF** button.
- 3 Select the operation mode with button, [**Cool**] or [**Heat**].
  - Do not run the air conditioner in a mode other than [**Cool**] or [**Heat**].
  - The temperature controlling function does not work during test run.
  - The detection of trouble is performed as usual.

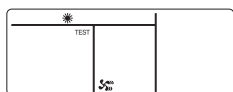

- 4 After the test run, push **ON/OFF** button to stop a test run. (Display part is same as procedure 1.)
- 5 Push **TEST** button to cancel (release from) the test run mode. ([TEST] disappears on the display and the status returns to a normal.)

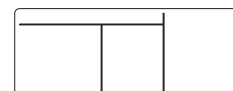

## Wireless remote controller

**Precaution: the test run method has been changed from this model.**

(RBC-AX32UM series)

- 1 Turn on the power of the air conditioner. When power is turned on for the first time after installation, it takes approx. 5 minutes until the remote controller becomes available. In the case of subsequent power-on, it takes approx. 1 minute until the remote controller becomes available. Execute a test run after the predetermined time has passed.
- 2 Push "ON/OFF" button on the remote controller, select [Cool] or [Heat] with "MODE" button, and then select [HIGH] with "FAN" button.

Cooling test run	Heating test run
Set the temperature to 17°C with the temp. setup buttons.	Set the temperature to 30°C with the temp. setup buttons.

Cooling test run	Heating test run
After confirming a signal receiving sound "beep" immediately set the temperature to 18°C with the temp. setup buttons.	After confirming a signal receiving sound "beep" immediately set the temperature to 29°C with the temp. setup buttons.

Cooling test run	Heating test run
After confirming a signal receiving sound "beep" immediately set the temperature to 17°C with the temp. setup buttons.	After confirming a signal receiving sound "beep" immediately set the temperature to 30°C with the temp. setup buttons.

- 6 Repeat procedures 4 → 5 → 4 → 5. Indicators "Operation" (green), "Timer" (green), and "Ready" (orange) in the wireless receiver section flash in approx. 10 seconds, and the air conditioner starts operation. If any of these indicators does not flash, repeat procedures 2 to 5.

- 7 Upon completion of the test run, push "ON/OFF" button to stop operation.

<Overview of test run operations using the wireless remote controller>

▼ **Cooling test run:**  
ON/OFF → 17°C → 18°C → 17°C → 18°C → 17°C → 18°C → 17°C → (test run) → ON/OFF

▼ **Heating test run:**  
ON/OFF → 30°C → 29°C → 30°C → 29°C → 30°C → 29°C → 30°C → (test run) → ON/OFF

## ■ When a test run is not performed properly

When a test run is not performed properly, refer to the check code and the part to be checked on "Troubleshooting".





# 10 Maintenance

## <Daily maintenance>

### ▼ Cleaning of air filter

- If  is displayed on the remote controller, maintain the air filter.

- 1 Push the  button to stop the operation, then turn off the circuit breaker. After the cooling or dry operation, the ventilation fan keeps running for self-cleaning. Push the  button twice to stop the operation.

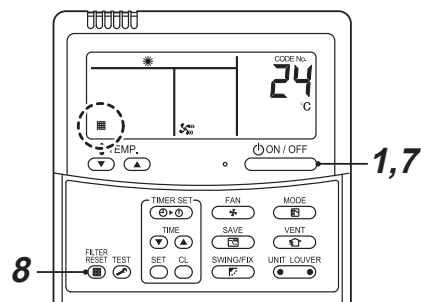

- 2 Open the air intake grille.

- 1) Loosen the fixing screw.

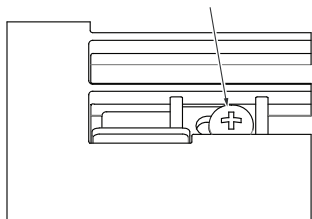

- 2) Slide the fixing bracket toward the inside.

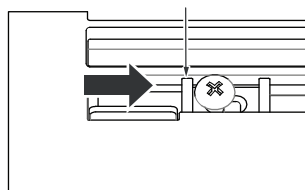

- 3) Holding the air intake grille, slide the hook in the direction of the arrow and slowly open the grille.

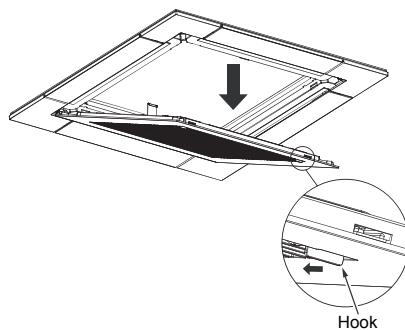
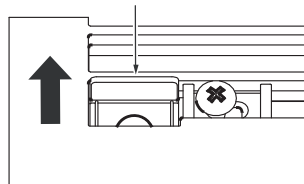

- 3 Take out the air filter.

- Push the extrusion of the air filter away from the grille and remove.

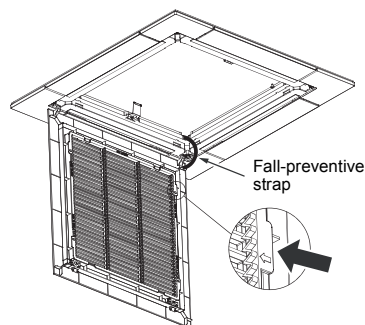

- 4 Cleaning with water or vacuum cleaner.

- If dirt is heavy, clean the air filter using tepid water with a neutral detergent or just water.
- After cleaning with water, dry the air filter sufficiently in a shaded place.





- 5 Mount the air filter.

- 6 Close the air intake grille.

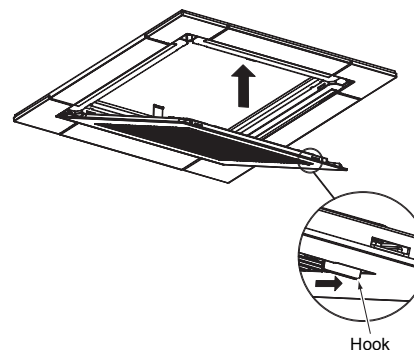
- Check that the fall-preventive strap of the air intake grille is attached to the panel.
- In inverse process of 1, firmly attach the hook, fixing bracket and fixing screw.



- 7 Turn on the circuit breaker, then push the  button on the remote controller to start the operation.

- 8 After cleaning, push .  display disappears.

### ⚠ CAUTION

- Do not start the air conditioner while leaving air filter removed.
- Push the filter reset button. ( indication will be turn off.)

▼ **Periodic Maintenance**

- For environmental conservation, it is strongly recommended that the indoor and outdoor units of the air conditioner in use be cleaned and maintained regularly to ensure efficient operation of the air conditioner. When the air conditioner is operated for a long time, periodic maintenance (once a year) is recommended. Furthermore, regularly check the outdoor unit for rust and scratches, and remove them or apply rustproof treatment, if necessary.

As a general rule, when an indoor unit is operated for 8 hours or more daily, clean the indoor unit and outdoor unit at least once every 3 months. Ask a professional for this cleaning / maintenance work.

Such maintenance can extend the life of the product though it involves the owner's expense.

Failure to clean the indoor and outdoor units regularly will result in poor performance, freezing, water leakage, and even compressor failure.

**Inspection before maintenance**

Following inspection must be carried out by a qualified installer or qualified service person.

Parts	Inspection method
Heat exchanger*	Open the air intake grille to remove the bell mouth and the fan, and then check the heat exchanger if there is any clogging or damages.
Fan motor	Check if any abnormal noise can be heard.
Fan	Open the air intake grille and check the fan if there are any waggles, damages or adhesive dust.
Filter	Open the air intake grille and check if there are any stains or breaks on the filter.
Drain pan*	Remove the panel, the bell mouth and the drain pan, and then check if there is any clogging, abnormal smell or drain water pollution.

\* Refer to the Service Manual for how to remove.

▼ **Maintenance List**

Part	Unit	Check (visual / auditory)	Maintenance
Heat exchanger	Indoor / outdoor	Dust / dirt clogging, scratches	Wash the heat exchanger when it is clogged.
Fan motor	Indoor / outdoor	Sound	Take appropriate measures when abnormal sound is generated.
Filter	Indoor	Dust / dirt, breakage	<ul style="list-style-type: none"> <li>Wash the filter with water when it is contaminated.</li> <li>Replace it when it is damaged.</li> </ul>
Fan	Indoor	<ul style="list-style-type: none"> <li>Vibration, balance</li> <li>Dust / dirt, appearance</li> </ul>	<ul style="list-style-type: none"> <li>Replace the fan when vibration or balance is terrible.</li> <li>Brush or wash the fan when it is contaminated.</li> </ul>
Air intake / discharge grilles	Indoor / outdoor	Dust / dirt, scratches	Fix or replace them when they are deformed or damaged.
Drain pan	Indoor	Dust / dirt clogging, drain contamination	Clean the drain pan and check the downward slope for smooth drainage.
Ceiling panel, louvres	Indoor	Dust / dirt, scratches	Wash them when they are contaminated or apply repair coating.
Exterior	Outdoor	<ul style="list-style-type: none"> <li>Rust, peeling of insulator</li> <li>Peeling / lift of coat</li> </ul>	Apply repair coating.

# 11 Troubleshooting

## ■ Confirmation and check

When a problem occurred in the air conditioner, the check code and indoor UNIT No. appear on the display part of the remote controller.

The check code is only displayed during the operation. If the display disappears, operate the air conditioner according to the following "Confirmation of check code" for confirmation.

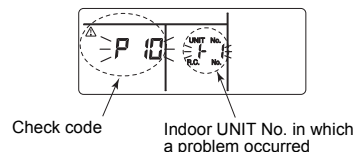

## ■ Confirmation of check code

When a problem occurred on the air conditioner, the check code can be confirmed with the following procedure. (The check code is stored in memory up to 4 check codes.)

The check code can be confirmed from both operating status and stop status.

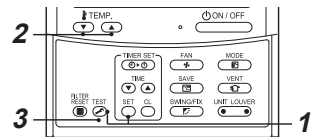

**1** When **SET** and **TEST** buttons are pushed simultaneously for 4 seconds or more, the following display appears.

If **P** is displayed, the mode enters in the check code mode.

- [01: Order of check code] is displayed in CODE No..
- [Check code] is displayed in CHECK.
- [Indoor unit address in which a problem occurred] is displayed in Unit No..

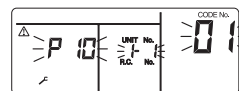

**2** Every pushing of **TEMP** button used to set temperature, the check code stored in memory is displayed in order.

The numbers in CODE No. indicate CODE No. [01] (latest) → [04] (oldest).

**REQUIREMENT**

Do not push **CL** button because all the check code of the indoor unit will be deleted.

**3** After confirmation, push **TEST** button to return to the usual display.

## ■ Check codes and parts to be checked

Wired remote controller display	Wireless remote controller Sensor block display of receiving unit		Main defective parts	Judging device	Parts to be checked / trouble description	Air conditioner status
	Indication	Operation Timer Ready GR GR OR				
E01	◎ ● ●		No header remote controller Remote controller communication trouble	Remote controller	Incorrect remote controller setting --- The header remote controller has not been set (including two remote controllers). No signal can be received from the indoor unit.	*
E02	◎ ● ●		Remote controller transmission trouble	Remote controller	Indoor / outdoor connecting wires, indoor P.C. board, remote controller --- No signal can be sent to the indoor unit.	*
E03	◎ ● ●		Indoor unit-remote controller regular communication trouble	Indoor	Remote controller, network adapter, indoor P.C. board --- No data is received from the remote controller or network adapter.	Auto-reset
E04	● ● ◎		Indoor unit-outdoor unit serial communication trouble IPDU-CDB communication trouble	Indoor	Indoor / outdoor connecting wires, indoor P.C. board, outdoor P.C. board --- Serial communication trouble between indoor unit and outdoor unit	Auto-reset
E08	◎ ● ●		Duplicated indoor addresses ★	Indoor	Indoor address setting trouble --- The same address as the self-address was detected.	Auto-reset
E09	◎ ● ●		Duplicated header remote controllers	Remote controller	Remote controller address setting trouble --- Two remote controllers are set as header in the double-remote controller control. (* The header indoor unit stops raising alarm and follower indoor units continue to operate.)	*
E10	◎ ● ●		CPU-CPU communication trouble	Indoor	Indoor P.C. board --- Communication trouble between main MCU and motor microcomputer MCU	Auto-reset
E11	◎ ● ●		Communication trouble between Application control kit and Indoor unit	Indoor	Communication trouble between Application control kit and Indoor unit	Entire stop
E18	◎ ● ●		Header unit follower unit regular communication trouble	Indoor	Indoor P.C. board --- Regular communication is not possible between header and follower indoor units or between twin header (main) and follower (sub) units.	Auto-reset
E31	● ● ◎		IPDU communication trouble	Outdoor	Communication trouble between IPDU and CDB	Entire stop
F01	◎ ◎ ●	ALT	Indoor unit heat exchanger sensor (TCJ) trouble	Indoor	Heat exchanger sensor (TCJ), indoor P.C. board --- Open-circuit or short-circuit of the heat exchanger sensor (TCJ) was detected.	Auto-reset
F02	◎ ◎ ●	ALT	Indoor unit heat exchanger sensor (TC) trouble	Indoor	Heat exchanger sensor (TC), indoor P.C. board --- Open-circuit or short-circuit of the heat exchanger sensor (TC) was detected.	Auto-reset
F04	◎ ◎ ○	ALT	Outdoor unit discharge temp. sensor (TD) trouble	Outdoor	Outdoor temp. sensor (TD), outdoor P.C. board --- Open-circuit or short-circuit of the discharge temp. sensor was detected.	Entire stop
F06	◎ ◎ ○	ALT	Outdoor unit temp. sensor (TE / TS) trouble	Outdoor	Outdoor temp. sensors (TE / TS), outdoor P.C. board --- Open-circuit or short-circuit of the heat exchanger temp. sensor was detected.	Entire stop
F07	◎ ◎ ○	ALT	TL sensor trouble	Outdoor	TL sensor may be displaced, disconnected or short-circuited.	Entire stop
F08	◎ ◎ ○	ALT	Outdoor unit outside air temp. sensor trouble	Outdoor	Outdoor temp. sensor (TO), outdoor P.C. board --- Open-circuit or short-circuit of the outdoor air temp. sensor was detected.	Operation continued
F10	◎ ◎ ●	ALT	Indoor unit room temp. sensor (TA) trouble	Indoor	Room temp. sensor (TA), indoor P.C. board --- Open-circuit or short-circuit of the room temp. sensor (TA) was detected.	Auto-reset

Wired remote controller display	Wireless remote controller Sensor block display of receiving unit		Main defective parts	Judging device	Parts to be checked / trouble description	Air conditioner status
	Indication	Operation Timer Ready GR GR OR				
F12	◎ ◎ ○	ALT	TS sensor trouble	Outdoor	TS sensor may be displaced, disconnected or short-circuited.	Entire stop
F13	◎ ◎ ○	ALT	Heat sink sensor trouble	Outdoor	Abnormal temperature was detected by the temp. sensor of the IGBT heat sink.	Entire stop
F15	◎ ◎ ○	ALT	Temp. sensor connection trouble	Outdoor	Temp. sensor (TE / TS) may be connected incorrectly.	Entire stop
F29	◎ ◎ ●	SIM	Indoor unit, other P.C. board trouble	Indoor	Indoor P.C. board --- EEPROM trouble	Auto-reset
F30	◎ ◎ ○	SIM	Occupancy sensor trouble	Indoor	Abnormality was detected from occupancy sensor.	Operation continued
F31	◎ ◎ ○	SIM	Outdoor unit P.C. board	Outdoor	Outdoor P.C. board ---- In the case of EEPROM trouble.	Entire stop
H01	● ◎ ●		Outdoor unit compressor breakdown	Outdoor	Current detect circuit, power voltage --- Minimum frequency was reached in the current releasing control or short-circuit current (Idc) after direct excitation was detected	Entire stop
H02	● ◎ ●		Outdoor unit compressor lock	Outdoor	Compressor circuit --- Compressor lock was detected.	Entire stop
H03	● ◎ ●		Outdoor unit current detect circuit trouble	Outdoor	Current detect circuit, outdoor unit P.C. board --- Abnormal current was detected in AC-CT or a phase loss was detected.	Entire stop
H04	● ◎ ●		Case thermostat operation	Outdoor	Malfunction of the case thermostat	Entire stop
H06	● ◎ ●		Outdoor unit low-pressure system trouble	Outdoor	Current, high-pressure switch circuit, outdoor P.C. board --- Pressure sensor trouble was detected or low-pressure protective operation was activated.	Entire stop
L03	◎ ● ◎	SIM	Duplicated header indoor units ★	Indoor	Indoor address setting trouble --- There are two or more header units in the group.	Entire stop
L07	◎ ● ◎	SIM	Group line in individual indoor unit ★	Indoor	Indoor address setting trouble --- There is at least one group-connected indoor unit among individual indoor units.	Entire stop
L08	◎ ● ◎	SIM	Indoor group address not set ★	Indoor	Indoor address setting trouble --- Indoor address group has not been set.	Entire stop
L09	◎ ● ◎	SIM	Indoor unit capacity not set	Indoor	Indoor unit capacity has not been set.	Entire stop
L10	◎ ○ ◎	SIM	Outdoor unit P.C. board	Outdoor	In the case of outdoor P.C. board jumper wire (for service) setting trouble	Entire stop
L20	◎ ○ ◎	SIM	LAN communication trouble	Network adapter central control	Address setting, central control remote controller, network adapter --- Duplication of address in central control communication	Auto-reset
L29	◎ ○ ◎	SIM	Other outdoor unit trouble	Outdoor	Other outdoor unit trouble 1) Communication trouble between IPDU MCU and CDB MCU 2) Abnormal temperature was detected by the heat sink temp. sensor in IGBT.	Entire stop
L30	◎ ○ ◎	SIM	Abnormal external input into indoor unit (interlock)	Indoor	External devices, outdoor unit P.C. board --- Abnormal stop due to incorrect external input into CN80	Entire stop
L31	◎ ○ ◎	SIM	Phase sequence trouble, etc.	Outdoor	Power supply phase sequence, outdoor unit P.C. board --- Abnormal phase sequence of the 3-phase power supply	Operation continued (the most at OFF)
P01	● ◎ ◎	ALT	Indoor unit fan trouble	Indoor	Indoor fan motor, indoor P.C. board --- Indoor AC fan trouble (fan motor thermal relay activated) was detected.	Entire stop
P03	◎ ● ◎	ALT	Outdoor unit discharge temp. trouble	Outdoor	An trouble was detected in the discharge temp. releasing control.	Entire stop

Wired remote controller display	Wireless remote controller Sensor block display of receiving unit		Main defective parts	Judging device	Parts to be checked / trouble description	Air conditioner status
	Indication	Operation Timer Ready GR GR OR				
P04	○ ● ○	ALT	Outdoor unit high-pressure system trouble	Outdoor	High-pressure switch --- The IOL was activated or an trouble was detected in the high-pressure releasing control using the TE.	Entire stop
P05	○ ● ○	ALT	Open phase detected	Outdoor	The power wire may be connected incorrectly. Check open phase and voltages of the power supply.	Entire stop
P07	○ ● ○	ALT	Heat sink overheat	Outdoor	Abnormal temperature was detected by the temp. sensor of the IGBT heat sink.	Entire stop
P10	● ○ ○	ALT	Indoor unit water overflow detected	Indoor	Drain pipe, clogging of drainage, float switch circuit, indoor P.C. board --- Drainage is out of order or the float switch was activated.	Entire stop
P12	● ○ ○	ALT	The fan trouble of the indoor unit	Indoor	Abnormal operation of the indoor fan motor, indoor P.C. board, or indoor DC fan (over current or lock, etc.) is detected.	Entire stop
P15	○ ● ○	ALT	Gas leakage detected	Outdoor	There may be gas leakage from the pipe or connecting part. Check for gas leakage.	Entire stop
P19	○ ● ○	ALT	4-way valve trouble	Outdoor (Indoor)	4-way valve, indoor temp. sensors (TC / TCJ) --- An trouble was detected due to temperature drop of the indoor unit heat exchanger sensor when heating.	Auto-reset
P20	○ ● ○	ALT	High-pressure protective operation	Outdoor	High-pressure protection	Entire stop
P22	○ ● ○	ALT	Outdoor unit fan trouble	Outdoor	Outdoor unit fan motor, outdoor unit P.C. board --- An trouble (overcurrent, locking, etc.) was detected in the outdoor unit fan drive circuit.	Entire stop
P26	○ ● ○	ALT	Outdoor unit inverter ldc activated	Outdoor	IGBT, outdoor unit P.C. board, inverter wiring, compressor --- Short-circuit protection for compressor drive circuit devices (G-Tr / IGBT) was activated.	Entire stop
P29	○ ● ○	ALT	Outdoor unit position trouble	Outdoor	Outdoor unit P.C. board, high-pressure switch --- Compressor motor position trouble was detected.	Entire stop
P31	○ ● ○	ALT	Other indoor unit trouble	Indoor	Another indoor unit in the group is raising an alarm.	Entire stop
					E03/L07/L03/L08 alarm check locations and trouble description	Auto-reset

○ : Lighting ◎ : Flashing ● : OFF ★ : The air conditioner automatically enters the auto-address setting mode.  
 ALT: When two LEDs are flashing, they flash alternately. SIM: When two LEDs are flashing, they flash in synchronization.  
 Receiving unit display OR: Orange GR: Green







**TOSHIBA CARRIER CORPORATION**

336 TADEHARA, FUJI-SHI, SHIZUOKA-KEN 416-8521 JAPAN

**EB99819101**